

EZI-FLO™ Rainwater Systems

– Innovative products –

Roofing
Industries
roof.co.nz

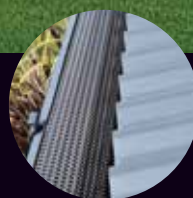
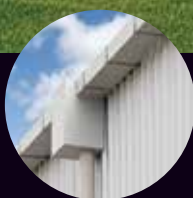
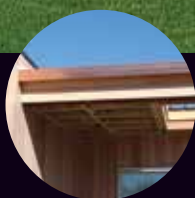

When selecting any of the Roofing Industries Ezi-Flo™ Rainwater Systems, you can be assured of receiving the most technically advanced, innovative and aesthetically pleasing products available all which have been specifically designed to perform across New Zealand's challenging climatic environs.

www.roof.co.nz

100% NZ Owned and Manufactured

EZI-FLO™

Traditional Spouting Systems

A comprehensive selection of modern and contemporary spouting systems designed to be both functional, aesthetically pleasing and suited to most residential and some commercial applications irrespective of roofing style and materials used.

Quarter Round

Quarter Round Spouting maintains its traditional appeal, and provides simplicity with classic lines for use in most residential applications.

Supplied with internal or colour-matched external brackets.

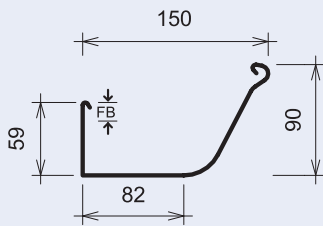

Full cross sectional area: 6815mm²



Old Gothic

Old Gothic, which is available in two sizes, is reminiscent of the spouting types used on colonial homes.

Supplied with internal or colour-matched external brackets.

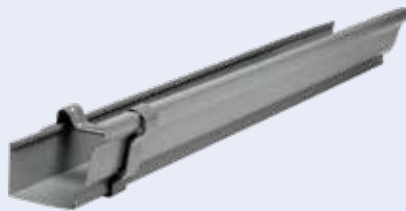
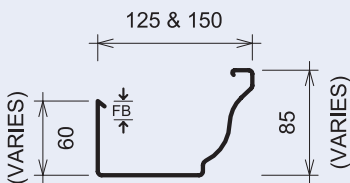

Full cross sectional area (125): 6000mm²



J Line

An extremely popular spouting system which utilises an extended sloping face to hide the end of the roofing and is particularly beneficial for use on low roof-pitch residential applications. Supplied with internal brackets.

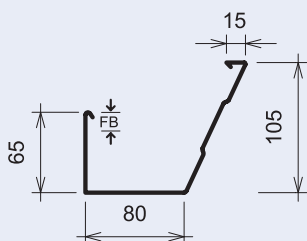

Full cross sectional area: 6240mm²



Lengths: Spouting products are manufactured to any length with a maximum of 8000mm. Other lengths may be available by application.

Materials: Ezi-Flo™ Traditional Spouting is available as Zinalume, Galvanised, Aluminium, Stainless Steel, Copper, Zinc, Zinc Magnesium Alloy, Colorcote® and Colorsteel® pre-painted modern colour surface finishes. Additional specialised substrates and paint coatings may be available subject to minimum order.

1/2 Round 168mm

An aesthetically pleasing spouting product and coupled with an excellent water holding capability, most certainly adds style and functionality to any home.

Supplied with colour-matched external brackets.

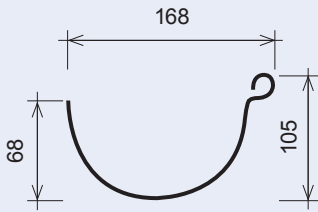

Full cross sectional area: 7930mm²

1/2 Round Swaged

A recent and attractive addition to the 1/2 Round spouting range and manufactured with a twin swaged front.

Supplied with colour-matched external brackets.

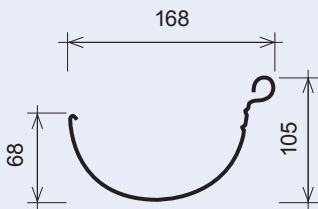

Full cross sectional area: 7930mm²

1/2 Round Flat Back

A marginally narrower version than traditional 1/2 Round and incorporates a "flat back" shape designed to reduce the cavity area under and behind the spouting. An additional twin strengthening swage is manufactured into the front of the spouting for commercial applications.

Supplied with internal or colour-matched external brackets.

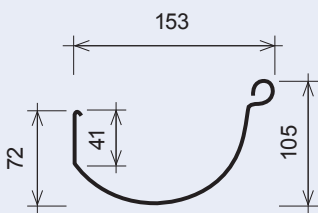

Full cross sectional area: 8050mm²

1/2 Round Flat Back Swaged

Similar to 1/2 Round "flat back" however has a twin swage manufactured into the front of the spouting.

Supplied with standard concealed brackets. External colour-matched brackets are available to order.

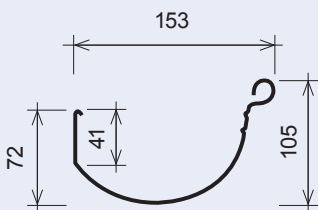

Full cross sectional area: 8050mm²



EZI-FLO™

Gutter Systems

A comprehensive selection of modern and contemporary gutter systems designed to be both functional, aesthetically pleasing and suited to both residential and commercial roof types.

125mm Box Gutter

A high flow gutter system designed to perform in both residential and commercial applications and where heavy rainfall intensities may occur. A higher face also prevents unsightly views of the end of the roofing, particularly where higher ribbed profiles have been used.

Supplied with unpainted or post painted concealed fixing clips. External brackets available to specific request.

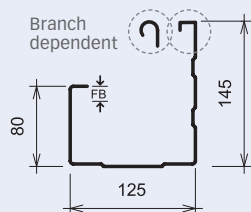

Full cross sectional area: 10000mm²



175mm Box Gutter

A bold and strong gutter and when coupled with appropriate downpipes has a relatively high flow rate for use in commercial applications.

Supplied with unpainted or post painted internal clips or external brackets.

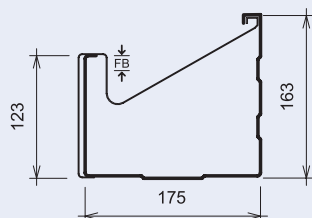

Full cross sectional area: 21525mm²



300mm Box Gutter

A large commercial and industrial extra wide gutter supported by heavy duty external holding brackets and primarily designed to discharge large amounts of water over a relatively short period of time.

Supplied with unpainted or post painted heavy duty external brackets.

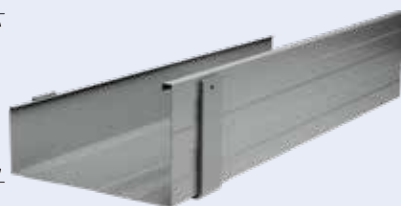
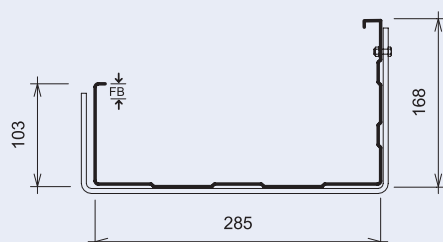

Full cross sectional area: 29355mm²





Lengths: 125, 175 and 300 Box gutters are manufactured to any length with a maximum of 8000mm. Other lengths may be available by application.

Materials: Ezi-Flo™ Gutters are available as Zinalume, Galvanised, Aluminium, Stainless Steel, Copper, Zinc, Zinc Magnesium Alloy, Colorcote® and Colorsteel® prepainted modern colour surface finishes. Additional specialised substrates and paint coatings may be available subject to minimum order.

Custom Design

Purpose made gutters can also be manufactured to meet specific project requirements with appropriate external or internal brackets supplied to suit.

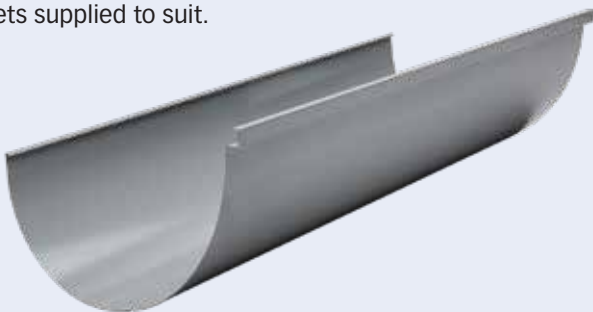

Lengths: Custom designs are manufactured to any length with a maximum of 8000mm. Other lengths may be available by application.

Materials: Custom designs are available as Zinalume, Galvanised, Aluminium, Stainless Steel, Copper, Zinc, Zinc Magnesium Alloy, Colorcote® and Colorsteel® prepainted modern colour surface finishes. Additional specialised substrates and paint coatings may be available subject to minimum order.

EZI-FLO™

Fascia Systems

An extremely practical and attractive Metal Fascia system and available with a smooth or embossed faced option. As the name suggests, Multifit™ external fascia can be used in conjunction with all roof and spouting types, is suitable for a large number of building designs and incorporates a proprietary attachment system.

Multifit™ External Fascia

Multifit™ external fascia has become the popular fascia system mostly replacing the timber fascia of yesteryear. Simply select your desired spouting type and is fitted to the outside fascia with adjustable proprietary brackets.

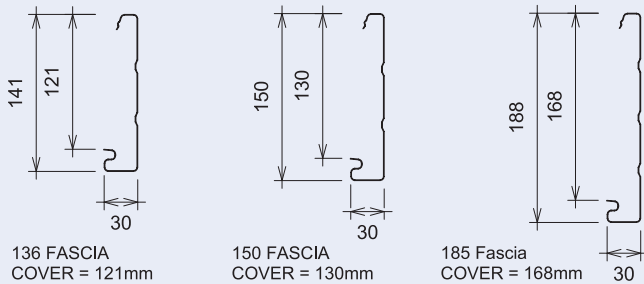

Multifit™ fascia is supplied up to 8000mm in length in a wide range of metal substrates and surface finishes including, Colorcote®, Colorsteel®, Copper, Stainless Steel, aluminium, Galvanised, Zinc Alloy Magnesium, Zinalume® and Zinc. Additional specialised substrates and paint coatings may be available subject to minimum order.

Important: Surface undulation "Oil Canning" Oil canning is defined as a perceived waviness across the flat area of (in particular, but not limited to) wider metal panels. It is a naturally-occurring phenomenon and can be more discernible under shallow cross lighting, variation in light source, temperature and thermal changes. Oil canning is an aesthetic issue and not a structural problem or defect. The property owner, builder, specifier should be aware that these undulations do not affect performance.

Rainwater Heads

Ezi-Flo™ Rainwater Heads can be an essential component of any residential or commercial efficient rainwater system enabling the smooth flow of water from the roof particularly during periods of intense rainfall. Roofing Industries highly skilled sheet metal tradespersons enjoy the challenge of custom-manufacturing rainwater heads meeting architectural design flair. Rainwater heads are supplied in an extensive range of material substrates and pre-painted surface finishes.



Ezi-Flo™ Rainwater heads are normally custom manufactured to meet design and capability. Supplied as Zinc, Galvanised, Stainless Steel, Copper, Aluminium and Colorcote®, Colorsteel® surface finishes. Contact Roofing Industries for specific assistance.

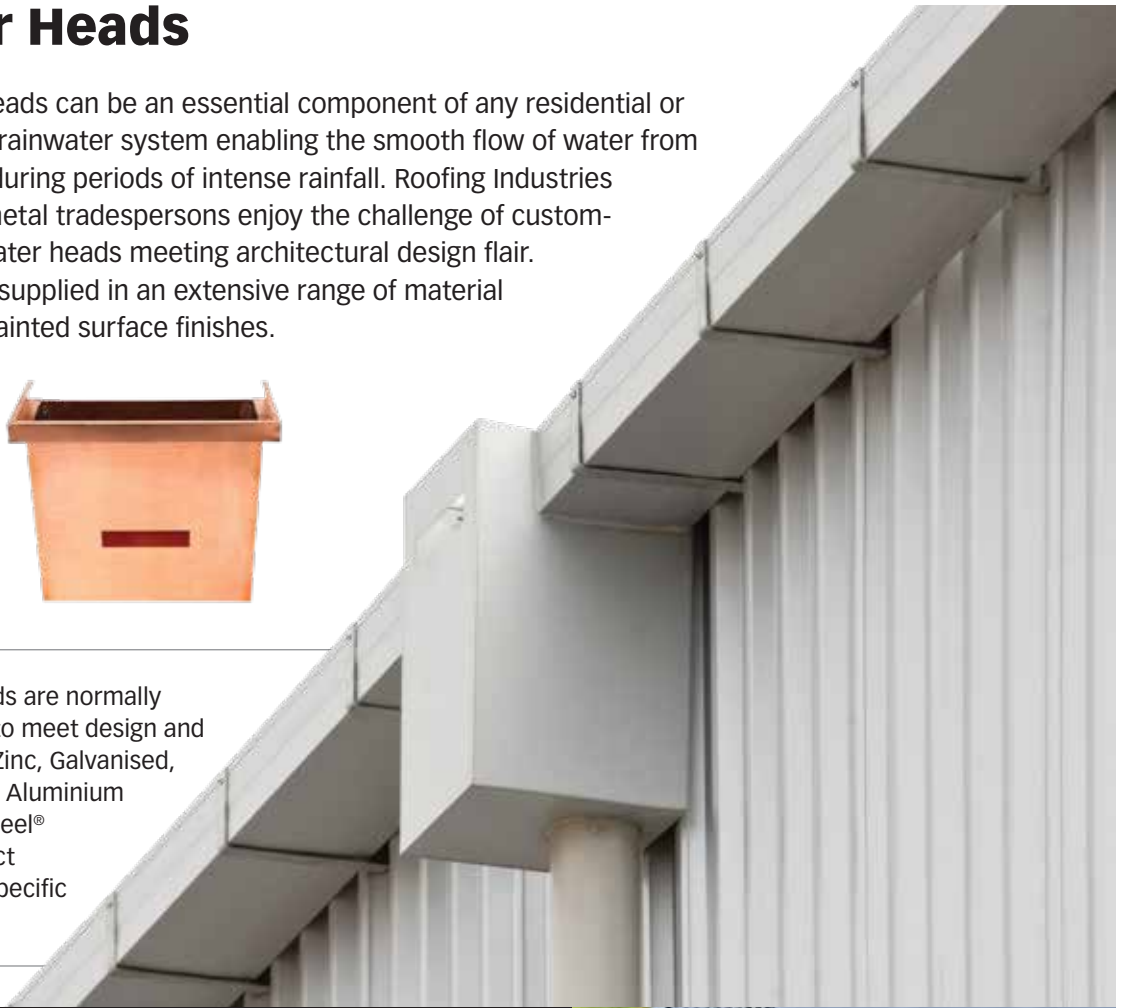

Ezi-Lok™
Gutter Screen

Ezi-Lok™
Valley Screen

Aluminium non-rusting New Zealand developed spouting and roof valley protection systems that are simple to install and remove for ease of cleaning.

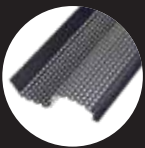

Unfortunately grime and seed is continually deposited on your roof via weather, birds and vermin. This washes through most screens and into gutters and valleys ensuring a perfect growing medium for unsightly weeds and grasses.



Traditional gutter screen systems tend to be permanently fixed in position and the only way to remove debris is to water blast through the mesh system, which is difficult, ineffective and rather messy to say the least.



Revolutionary Ezi-Lok™ Gutter Screen and Ezi-Lok™ Valley Screen systems on the other hand are compatible with most types of modern gutter and roofing products and simply snapped into or out of position.



Colours: Ironsand and Light Grey **Lengths:** Stock lengths are 1800mm.

EZI-FLO™

Downpipe Systems

Ezi-Flo™ Downpipes are aesthetically appealing and innovatively manufactured using proprietary bends and joiners thereby providing unobstructed water flow from the guttering to stormwater drainage and more importantly, reducing the possibility of rainwater ingress.

Supplied in both Round and Rectangular shapes of various lengths, Ezi-Flo™ Downpipes are manufactured using an extensive range of metal substrates and surface finishes, including Colorcote® and Colorsteel® to suit modern building design requirements. Stock lengths are 3200mm however other lengths can be manufactured subject to building regulation and material availability.

Round

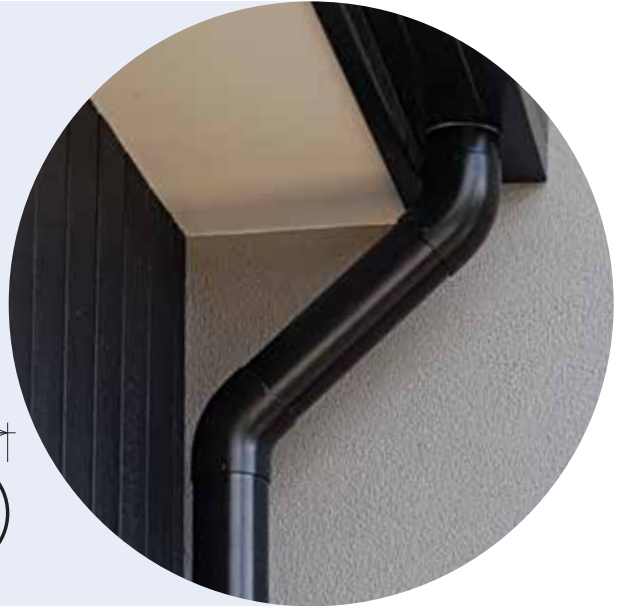
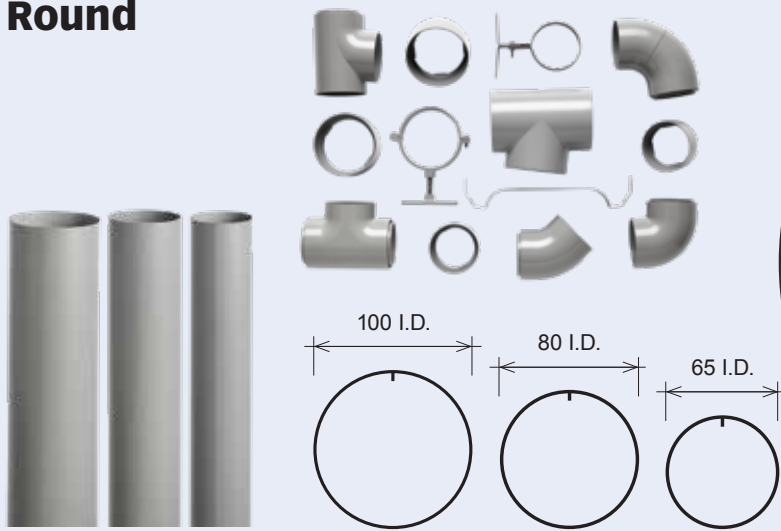

Rectangle

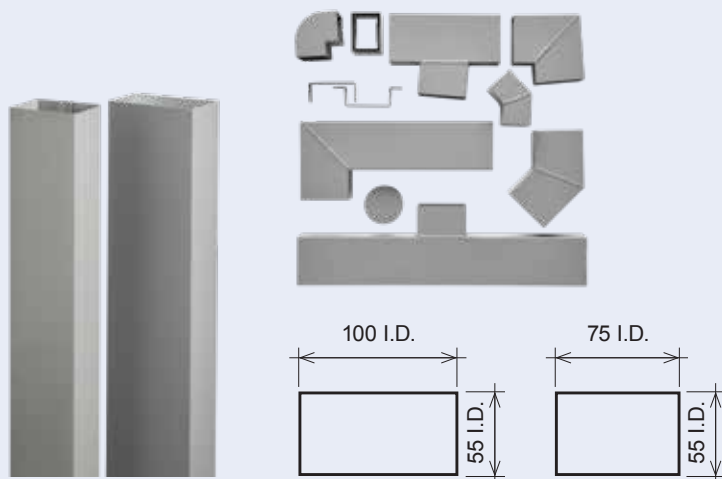

Lengths: Ezi-Flo™ Round and Rectangle downpipes are supplied in stock lengths of 3200mm. Manufactured to length downpipes can be supplied subject to pricing, material availability and some length limitation requirements.

Materials: Ezi-Flo™ Downpipes are available as Zinalume, Galvanised, 1.6mm extruded Aluminium, Alumiguard™, Stainless Steel, Copper, Zinc, Zinc Magnesium Alloy, Colorcote® and Colorsteel® pre-painted modern colour surface finishes. Additional specialised substrates and paint coatings may be available subject to minimum order.

NOTE: Ezi-Flo™ products are generic to Roofing Industries nationally, however due to manufacturing capability there may be some variation between Branches.

*All dimensions in millimetres and are nominal

Rainwater Systems

TECHNICAL NOTES

Roofing Industries is well recognised as a manufacturer of highly innovative rainwater products primarily designed to perform in our challenging climatic environment and where potential corrosive conditions abound. When appropriately specified, installed and maintained, products will most certainly complement any project. Additional to information contained within the technical notes, Roofing Industries technical helpline can be contacted or alternatively our website visited at www.roof.co.nz for specific advice.

Roof Drainage Performance

It is imperative that the appropriate rainwater system, comprising, gutters, spouting, fascia, brackets and downpipes are correctly specified and then installed accordingly to ensure rapid shedding of water from the roof via downpipes to the groundwater system. Failure to implement an efficient rainwater system can result in water ingress and significant water damage to property.

Roof drainage performance design must take the following factors into account:

- Roof pitch
- Rainfall intensity
- Catchment area
- Cross sectional area of the rainwater carrying system including downpipes
- Rainhead design
- Efficiency of flow rate and water discharge via the Downpipe(s)
- Overflows
- Roofing profile capacity
- Roof penetrations which may obstruct water flow

Further information in relation to all roof drainage charts and calculations, refer NZ Metal Roofing and Wall Cladding Code of Practice or visit our website www.roof.co.nz.

Rainfall Intensity

Rainfall intensity can be taken off the maps for 50-year Average Return Intervals (ARI). When the co-ordinates of a site are known, site-specific values can be obtained using the information from NZMRM Code of Practice (COP).

Snowfall

Where snow may collect on the roof and the rainwater system, it is recommended Roofing Industries staff are consulted for design and appropriate installation instructions including the possibility of using snow straps.

Drinking Water and Run Off

All Roofing Industries Rainwater products are compatible for the collection of drinking water. It is advisable practice for Local Territorial Authorities to be consulted prior to collection of drinking water. Where necessary, water run off from dissimilar materials should be contained and discharged using compatible materials.

Durability

Environmental and climatic guides are available from www.roof.co.nz and should be consulted prior to selection of appropriate metal substrates and surface finishes.

Expansion and Contraction

- The maximum gutter-length is determined by the type of metal and its colour. Where gutters/spouting have an allowance for expansion, lengths should be restricted to 25 metres for steel substrate and 12 metres for copper or aluminium.
- An expansion joint can be either a sump, rainwater head or a saddle flashing.
- Gutters and spouting should not be formed or attached in such a way to prevent adequate movement.

Gutter and Spouting Brackets

- The spouting and gutter bracket system must withstand the potential weight when full of water. In snow load areas, spouting may be fitted with snow straps and brackets at a maximum of 600mm centres to withstand the additional stress of any snow build-up.
- Brackets should be made using compatible material or non-ferrous metal. Brackets for pre-painted external gutters and spouting should be painted or powder coated before installation. For some gutter and spouting types, both external and internal bracket options may be available.
- Brackets for external gutters should be located close to all stop-ends, at both ends of sumps and rain-heads at a maximum of 750mm spacing for gutters less than 180mm wide, and at 600mm for gutters 180 – 300mm wide. Brackets must be installed to provide a 1:500 (2mm per metre) minimum gutter gradient towards the outlets.

Stop Ends, Pre-made Mitre Corners, Downpipe Droppers and Rainheads

- Roofing Industries offers a range of pre-made stop-ends, mitre corners, dropper outlets, and rainheads. Utilising these components ensures a professionally finished gutter installation can be achieved. If using pre-made stop ends, rivet and silicone them to the gutter ends as required.



Rainheads

- When ordering non-standard rainhead products, the following information will be needed prior to manufacture: Material, gauge, width x depth x height measurement, Dropper size, shape and positioning, any slot width, height, shape, positioning and architectural shape preference.

Downpipes

- Downpipes must be compatible with the roof and gutter material and must comply with the 5-year durability requirement of the NZBC.
- The placement of downpipes significantly affects gutter and downpipe calculations. refer to NZ Metal Roof and Wall Cladding Code of Practice calculator for more info.
- Jointing downpipe must be sealed and held with a minimum of two 3mm aluminium rivets or flat head 5.4mm x 16mm self drilling screws to each joint.

- Round and rectangular shapes can be made available in lengths up to 6000m long. These require fabricating, riveting and sealing together with a neutral curing silicone sealant.
- Stop ends have locating lugs which allow the stop ends to be located on the cut end of the gutter and provide secure positioning before sealing with a neutral silicon sealant and riveting onto the gutter with 2 x 4-3mm diameter compatible rivets.

Ordering

Roofing Industries staff can provide technical assistance to ensure accurate recommendation and ordering of the rainwater system thereby avoiding costly errors. Spouting, gutters, downpipes fascia and may be manufactured and delivered cut to length however are subject to thermal movement restriction and design limitations. Note: Stock lengths of aluminium downpipes – 3200mm.

Handling and Storage

On delivery, visually inspect products for signs of damage.

Store spouting, gutters, fascia, downpipes and related accessories on evenly spaced and supportive dunnage, clear of the ground and under cover, paying particular attention to preventing the placement of other goods on top of the products creating potential damage.

All rainwater products should be protected from wind and impact damage whilst in storage on site and prior to being installed.

If rainwater goods become wet during storage and the products are not being used immediately, separate the materials to allow air circulation and drying.

Do not drag rainwater products and their accessories across each other.

If protected with strippable plastic film, keep goods under cover, away from UV light and remove as the product is being installed.

Gutter and Spouting Fall

Determine gutter and spouting fall by running a taut string line to each corner where the product is to be installed and use a spirit level to check the fall. Ideally the fall should be a minimum of 1:500 (2mm in 1 metre), however for improved drainage and self – cleaning, Roofing Industries recommends 1:200 (5mm in 1 metre) .

General Installation Requirements

- Fasteners must be compatible with the materials used.
- Do not use black lead pencils for the markings on products.
- Ensure the gutter/spouting has a minimum cross sectional area of 4000mm².
- Ensure that the roof overhang into the gutter is minimum 50mm.
- The use of abrasive disc cutters or grinders above or adjacent to the products by roofers or other trades is against trade practice and must be avoided, otherwise, swarf staining will result. Cutting must be done by shear method or using tin snips.
- Run a string line taut from corner to corner. Use a spirit level to check the fall. If physically measuring fall is hard, rely on spirit level readings as opposed to measurements. Mark the gutter fall and reference when installing gutters.
- Every joint should have a thin and uniform bead of neutral cure silicone sealant is applied once surfaces have been riveted in place. Ensure the joint is fixed and sealed full girth. Wipe off excess sealant to ensure water flow is not obstructed.
- Lap spouting joint in the direction of water flow, a minimum cover of 40mm seal joint should be made using sealant at both ends of lap and fix with compatible colour matching rivets. All sealed joints

Calculating actual fall for Gutter and Spouting.

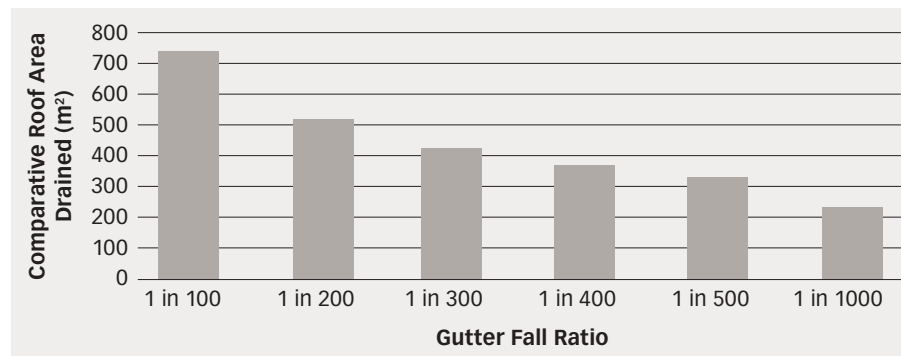

- must be mechanically fastened and excessive sealant removed to prevent unnecessary dirt build-up or a restriction in water flow.
- At all times, contact with wet concrete, lime, mortar acids, and treated timber must be avoided.
- External gutters and spouting must be installed with the back lower than the fascia board or cladding.
- During installation, the spouting must be cleaned of all loose debris.
- To remove contaminants, on completion all products must be cleaned by hosing and soft brushing.
- Form the hole in the bottom of the spouting/gutter and fit preformed downpipe droppers, silicone seal and rivet in place.

Note: For full comprehensive installation instruction across all products, see www.roof.co.nz supported by the NZ Metal Roof and Wall Cladding Code of Practice.

Maintenance

Regular maintenance will extend the life of rainwater systems, and it is especially important to keep all surfaces free from dirt, leaves and debris accumulation, paying particular attention to the requirement of frequent freshwater washing of the undersides of gutters and spouting which may not receive regular rain washing or alternatively are installed in a corrosive environment.

On purchasing Roofing Industries rainwater products it is imperative to request a copy of the maintenance guide(s) and familiarise yourself with industry guidelines. Publications and recommendations are available via the website www.roof.co.nz and must be adhered to, as failure to do so can void any warranty.

Warranties

Warranties meet the statutory requirements of the NZ Building Code, are available on request and reflect our New Zealand owned and operated company, test facilities and local climatic conditions.

Minimum Order Quantity

Some materials and surface finishes are subject to subject to minimum product order.





Roofing Industries Branches

Auckland	(Head Office) 5 John Glenn Avenue, North Harbour 0632	Ph:(09) 414 4585	E:auckland@roof.co.nz
Whangarei	4A Fraser Street, Whangarei 0112	Ph:(09) 437 2040	E:northland@roof.co.nz
Pukekohe	212 Manukau Road, Pukekohe, South Auckland 2120	Ph:(09) 238 0050	E:franklin@roof.co.nz
Hamilton	78 Sunshine Avenue, Te Rapa, Hamilton 3241	Ph:(07) 849 5115	E:waikato@roof.co.nz
Tauranga	98 Birch Avenue, Tauranga 3110	Ph:(07) 578 2650	E:tauranga@roof.co.nz
Mount Maunganui	49 Aerodrome Road, Mt. Maunganui 3116	Ph:(07) 929 7034	E:tauranga@roof.co.nz
Taupo	1158 Rakaunui Road, Taupo 3351	Ph:(07) 376 7971	E:taupo@roof.co.nz
Napier	39A Turner Place, Onekawa, Napier 4110	Ph:(06) 281 2586	E:napier@roof.co.nz
New Plymouth	14 Constance Street, Waiwhakaiho, New Plymouth 4312	Ph:(06) 758 3003	E:taranaki@roof.co.nz
Palmerston North	653 Tremaine Avenue, Palmerston North 4410	Ph:(06) 353 8480	E:central@roof.co.nz
Wellington	2 Cashew Street, Grenada North, Wellington 5028	Ph:(04) 238 4390	E:wellington@roof.co.nz
Blenheim	Unit 3, 24 Herbert Street, Blenheim 7201	Ph:(03) 934 5901	E:blenheim@roof.co.nz
Christchurch	12 William Lewis Drive, Sockburn, Christchurch 8042	Ph:(03) 339 2324	E:christchurch@roof.co.nz
Cromwell	29A McNulty Road, Cromwell 9310	Ph:(03) 928 6869	E:cromwell@roof.co.nz

www.roof.co.nz 100% NZ Owned and Manufactured

Roofing Industries Technical Helpline 0800 844 822

