

# AMPeLite

## Lexan\* Thermoclear\* multiwall sheet



Photo, Courtesy of Telstra Stadium, Sydney.



SABIC  
Innovative  
Plastics™

سابك  
sabic

**Lexan\***  
Polycarbonate sheet

Tough  
Virtually  
Unbreakable

\* Trademark of Sabic Innovative Plastics IP BV

Authorised Distributor: Ampelite Australia Pty Ltd.

[www.ampelite.com.au](http://www.ampelite.com.au)



## TRANSLUCENT THERMAL GLAZING WITH



Residential pergola, Victoria. Lexan Thermoclear 10 mm opal



Girls Senior High School, Western Australia. Lexan Thermoclear 10 mm grey



Direct Factory Outlets, Victoria. Lexan Thermoclear Solar Control IR



Quarantine Greenhouse, Victoria. Lexan 8 mm Clear

Photo courtesy Redpath Ideal Greenhouses

# Lexan \*Thermoclear\* multiwall sheet

Lexan\* Thermoclear\* multiwall sheet is a high quality, low maintenance glazing material that is built to last. Based on Lexan polycarbonate resin, it delivers high impact strength, an excellent balance of low weight and high stiffness and naturally "water-clear" transparency.

From conservatories, commercial greenhouses and swimming pools, to industrial buildings, offices and sports stadiums, this versatile range of materials helps to deliver state-of-the-art, lightweight glazing for commercial, industrial and residential applications.

Ampelite stock 10 mm twinwall sheet which is widely used in small commercial and residential applications. In applications where superior stiffness is required, we can supply X-structures in gauges up to 32 mm thick.

**Fire Test Performance** - Thermoclear has achieved an Internal Surface Finish Group number of 1-S according to performance determined under the conditions described in ISO 9705:1993 required by NZBC clause C3.4(A). Performance is achieved through MBIE Guidance on European Classification.

**UV resistance** – Sabic's proprietary surface treatment represents the next generation in surface coating technology. According to accelerated testing, Lexan\* Thermoclear\* sheet is superior to other available polycarbonate multiwall glazing products.

**Comprehensive warranty** – most Lexan\* Thermoclear\* products carry a minimum 10-year limited written warranty against excessive yellowing, loss of light transmission and loss of strength due to weathering.

**Excellent energy efficiency** – the multiwall construction traps air between the layers, which ensures outstanding thermal insulation performance.

**Two-sides UV protection**-all Lexan\* Thermoclear\* multiwall sheet supplied by Ampelite features Sabic's proprietary UV protection to both sides, giving superior resistance to outdoor weathering and greater design flexibility.

**Ease of installation** – the flat structure of Lexan\* Thermoclear\* multiwall sheet allows the use of aluminium glazing bar systems for long-lasting performance. Unlike some multiwall glazing products, the sheet can be easily cut to length or width, allowing for variations between construction and design.

**Light weight** – an outstanding balance of low weight and high stiffness enables lightweight structures with greater spans to be designed and easily installed.

**Curved glazing** – sheet can be cold-formed into tight radii without pre-forming. Generally, the minimum radius is 175 x the gauge. Ampelite have specialised glazing systems for curved applications.



# Innovative glazing solutions



## Typical applications

- Covered walkways
- Pergolas
- Shopping Centres
- Sports Complexes
- Swimming Pool Enclosures
- Industrial Glazing
- Greenhouses
- Screening/Partitioning

## Specification

"The translucent sheeting shall be 'Lexan\* Thermoclear\*\*' multiwall sheet as distributed by Ampelite Australia Pty Ltd. to comply with AS/NZS/ 4256 parts 1 & 3: 1994. The sheet shall have a gauge of \*10 mm and a width of \*\*1050 mm. The sheeting shall be fixed in accordance with Ampelite's \*\*\*H-Bar system. Both the sheeting and glazing bars will be supplied to conform with the nominated colour. Sheeting shall be installed in accordance with Ampelite fixing instructions and AS1562.3:2006 Design and installation of sheet roof and wall cladding Part 3: Plastic." \*Insert nominated gauge. \*\*Insert nominated width. \*\*\*Insert nominated glazing system.



**Lexan\*** Tough  
Polycarbonate sheet Virtually  
Unbreakable

\* Trademark of Sabic Innovative Plastics IP BV

## excels in tough conditions

- **Certified under Australian Standards – Exceptional performance in our harsh Australian environment. Excels where others fail.**
- **Wind resistance – Suitable for use in high wind areas, conforms to Australian Standard 1170.2.**
- **Fire Rating – Excellent performance, conforms to Australian Standard 1530.3:2006.**
- **Is one of the most widely used engineered materials in the world. Lexan Resin has contributed to product revolutions in virtually every industry.**
- **Energy Efficient – Excellent thermal performance, saves on air conditioning and heating costs.**
- **Impact resistant – Outstanding impact performance over a wide temperature range, -40°C to + 120°C.**
- **Impact strength 250 times higher than glass.**
- **Environmental Standards – In many cases Lexan\* Thermoclear\* high performance polycarbonate sheet products may be recycled.**
- **Warranty – Lexan\* Thermoclear\* multiwall sheet has a superior 10 year limited written warranty. Full warranty available on request.**

## Superior weatherability

In addition to the inherent properties of the Lexan\* Thermoclear\* Plus range, Lexan Thermoclear SunXP offers UV protection as standard on both sides, with even higher resistance to UV radiation, yellowing and loss of light transmission. This represents a revolutionary development in the use of plastic sheeting in Australia's harsh climate.

Lexan\* Thermoclear\* SunXP offers a 15 year warranty against excessive yellowing, loss of light transmission and hail damage.



## Heat management



The new Lexan Solar Control IR Sheet represents an entirely new technology in the field of energy efficiency. Proprietary resin additives are used to block near-infrared heat, while maintaining high levels of light transmission. Studies have shown that this can result in energy savings of 25-40% in a temperature controlled environment!

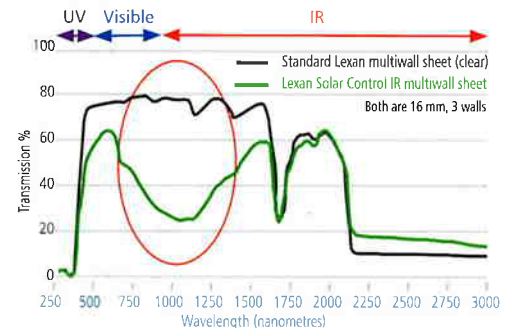

## Profile-free facades

Lexan\* Thermoclick\* sheet systems feature a unique tongue and groove connection to eliminate the need for vertical profiles, thereby improving aesthetics and potentially saving costs. The X-Structure of the sheet provides exceptional stiffness and thermal insulation.



Unique tongue and groove connection of Lexan\* Thermoclick\*

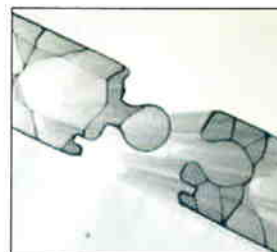

# Standard colours

These are the standard colours available from floor stock. Sheet widths and lengths are shown on the back page.

For non-standard products, colours and wall structures, please refer to Fig.1 on this page and information on page 4.

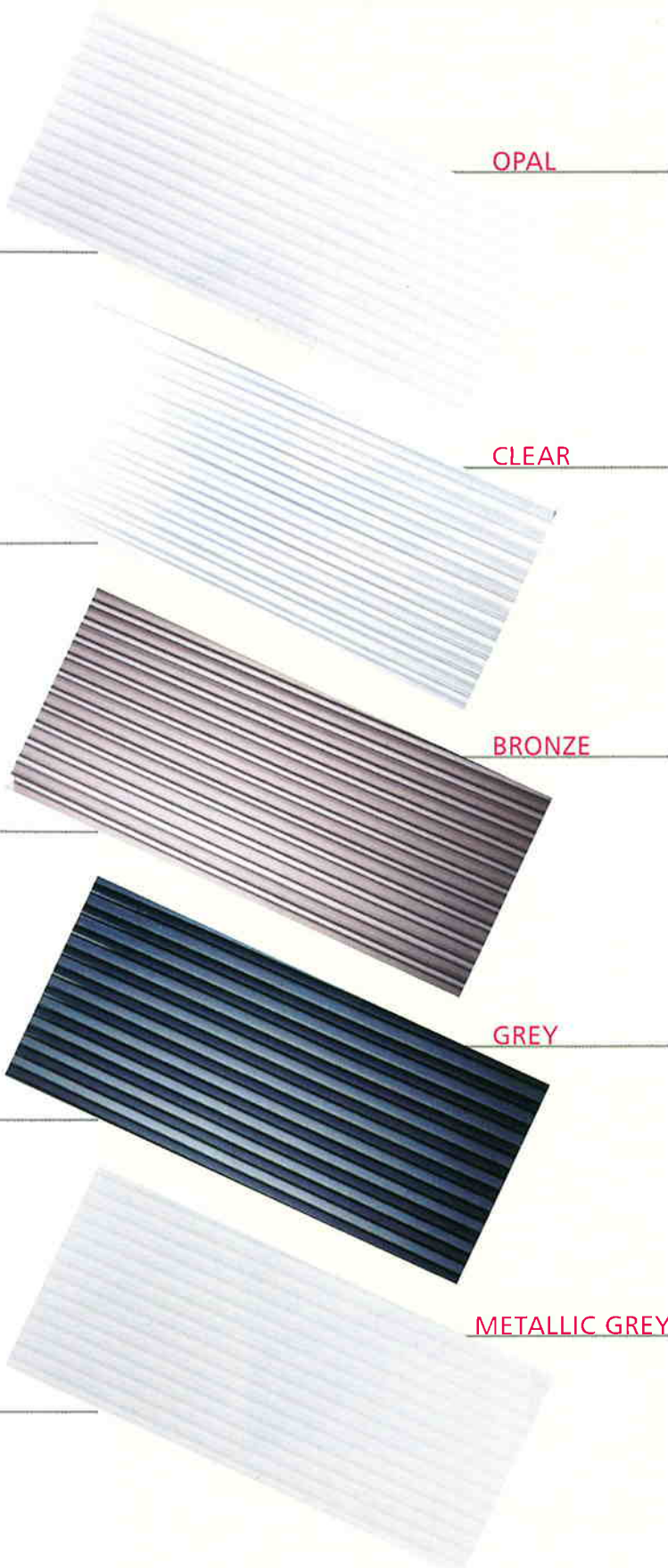

## Light transmission and Solar transmission

### 10 mm twin wall

K-Value: 3.0 W/m <sup>2</sup> .K	LT	TST	SC
Clear	81%	80%	0.92
Opal	64%	68%	0.78
Bronze	35%	55%	0.63
Grey	20%	50%	0.58
Metallic Grey	16%	29%	0.33

Note: Sheet widths and lengths are shown on the back page.

### 16 mm twin wall

K-Value: 2.4 W/m <sup>2</sup> .K	LT	TST	SC
Clear	74%	78%	0.90
Opal	63%	67%	0.79

Note: Sheet widths and lengths are shown on the back page.

## Available sheet structures

Ampelite recommend using standard gauge 10 mm twinwall sheeting for most residential and smaller commercial applications.

The 16 mm gauge is often specified for larger projects.

10 mm twin wall Sheet structure

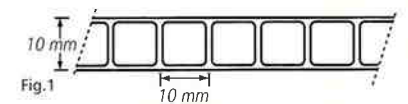

16 mm twin wall Sheet structure

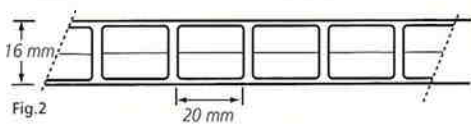

A range of other gauges to suit almost any project are available subject to order quantities. Please consult your nearest Ampelite office for current stock/lead time.

## Requirements for safety mesh

Some sheet structures may be used without safety mesh as per AS1562.3:2006. No multiwall polycarbonate sheet is trafficable, and should therefore only be walked upon with the use of walkboards. Please consult your nearest Ampelite office for details.

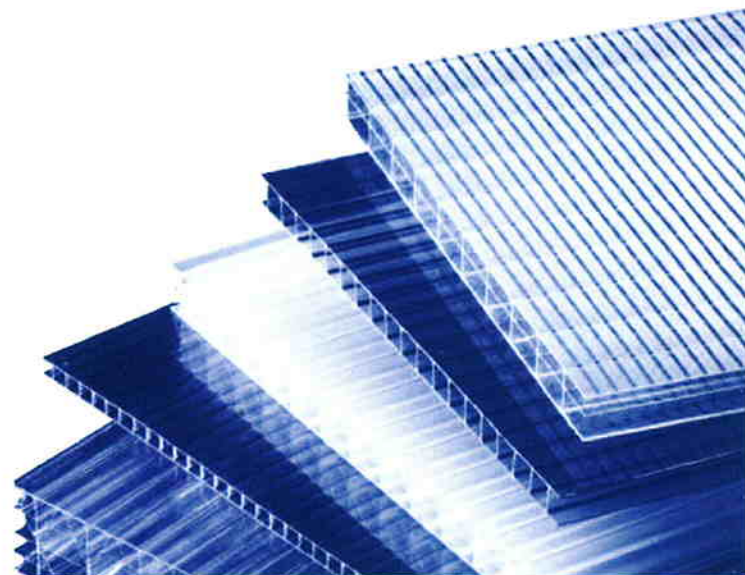



## Installation

Ampelite is able to supply various fitting systems to suit the application. For comprehensive installation details, please refer to separate installation instructions on our website at [www.ampelite.com.au](http://www.ampelite.com.au) or contact your nearest Ampelite office.

## Sheet colours, sizes and spanning

Colours: 10 mm – Clear, Opal, Bronze, Grey, Metallic Grey.  
16 mm – Clear, Opal.

Widths : 700 mm, 1050 mm (Metallic Grey 1050 mm only)

Lengths: 2 m, 2.5 m, 3.0 m, 3.5 m, 4.0 m, 4.5 m, 5.0 m, 5.5 m, 6.0 m, 7.0 m.

Other sizes and colours may be available. Please confirm availability before ordering.

Spans	700 mm		1050 mm	
	Rafters	Purlins	Rafters	Purlins
10 mm	720 mm	not required	1070 mm	not required
16 mm	720 mm	not required	1070 mm	not required

Above figures based on 1.5kPa.

For installation in high wind areas, please contact Ampelite.

### Sheet mass

10 mm	1700 gsm	16mm	2700 gsm
-------	----------	------	----------

## Ampelite glazing systems

### H-bar system

Very simple installation for standard applications using 10 mm or 16 mm gauge sheeting. Available in clear anodised and a variety of powdercoat colours.

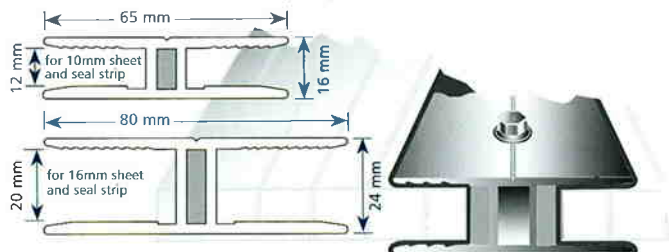

Dimensions nominal. Drawings not to exact scale.

### Flexibar system

Versatile system, recommended for use in curved applications or where non-standard gauge sheeting is to be used.

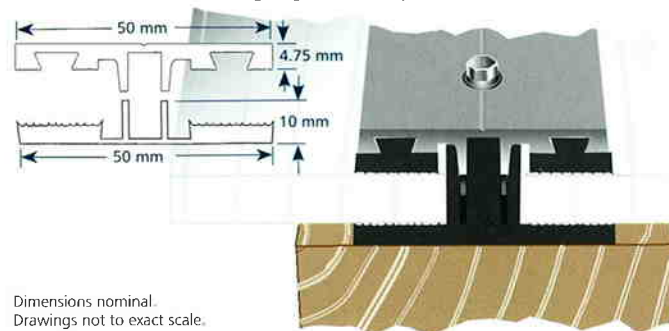

Dimensions nominal. Drawings not to exact scale.



Ampelite Australia Pty Ltd ABN 91 487 122 629

Vic & Tas: Tel 03 9794 0977. Fax 03 9794 0710. NSW & ACT: Tel 02 9625 7200. Fax 02 9625 7211.

Qld: Tel 07 3808 6211. Fax 07 3808 4799. SA & NT: Tel 08 8260 7391. Fax 08 8260 7397.

WA: Tel 08 9302 6833. Fax 08 9302 6855. NZ: Tel 09 634 5366. Fax 09 622 2060.

## UV protection

Lexan\* Thermoclear\* has been used on many of the largest sports stadiums in the world, including the Sydney and Beijing Olympic stadii. This is largely due to the proprietary surface coating technology, which has superior resistance to outdoor weathering.

According to accelerated 4,000 hours weathering tests, Lexan Thermoclear is superior to other available polycarbonate multiwall glazing products. This is reflected through a superior ten year limited written warranty.

The photos presented below show 3 polycarbonate multiwall sheet samples.

Sample 1 is a new sheet.

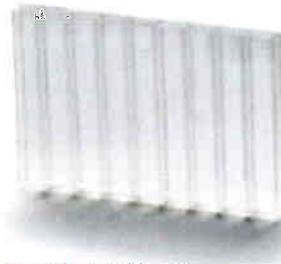

Sample 1:  $\Delta Y_i = 0$



Sample 2:  $\Delta Y_i = 2$   
Lexan Thermoclear Plus Sheet Warranty



Sample 3:  $\Delta Y_i = 10$   
Typical Multiwall PC sheet Warranty

The warranty states that clear Lexan Thermoclear sheets will not display a change in Yellowness Index of more than  $2\Delta$  (sample 2) compared with their original value (sample 1), whereas most other PC multiwall sheet producers warrant that their sheets will not display a change in Yellowness Index of more than  $10\Delta$  (sample 3). Lexan Thermoclear is also warranted for 10 years against hail damage and excessive loss of light transmission. Please consult your nearest Ampelite office for full warranty details.

For more information on new products or installation instructions, please visit our website at [www.ampelite.com.au](http://www.ampelite.com.au)

Ampelite is wholly Australian owned. Profits remain in Australia and taxes paid benefit our community.

