



DECORATIVE
EXTERIOR LIGHTING
& SENSORS



Simx Lighting prides itself on selecting only top quality products with reliable components and workmanship. Unique and often ground breaking features with real user benefits are high priorities in our selection process.

A key part of our process is in working directly with carefully selected manufacturers to design product that best suit New Zealand conditions. Whether that is by improving raw material selection, functionality, or changes to facilitate easier installation, we ready our products and look for ongoing improvements to ensure your experience with Simx Lighting is a positive one.

To this end, we have taken New Zealand's unique geography as inspiration for architectural design themes using our natural landscapes and colour tones as the basis for a set of new products which complement each other as well as modern New Zealand home design.

ESYLUX

Esylux a German-based innovator and manufacturer of intelligent automation and lighting solutions - a welcome addition to the Simx Ltd product offering.

In light of the often complex requirements, close attention is given to the simple operation of our product solutions. Together with ensuring the highest standards in quality, design, convenience and service are met, Esylux products are always delivering new, surprisingly easy solutions for the perfect synergy between automation and lighting in any space.

WALL LIGHTS

LIGHTING PEOPLE AND SPACES



TEKAPO



PUKAKI



HAWEA



WAKATIPU



WANAKA

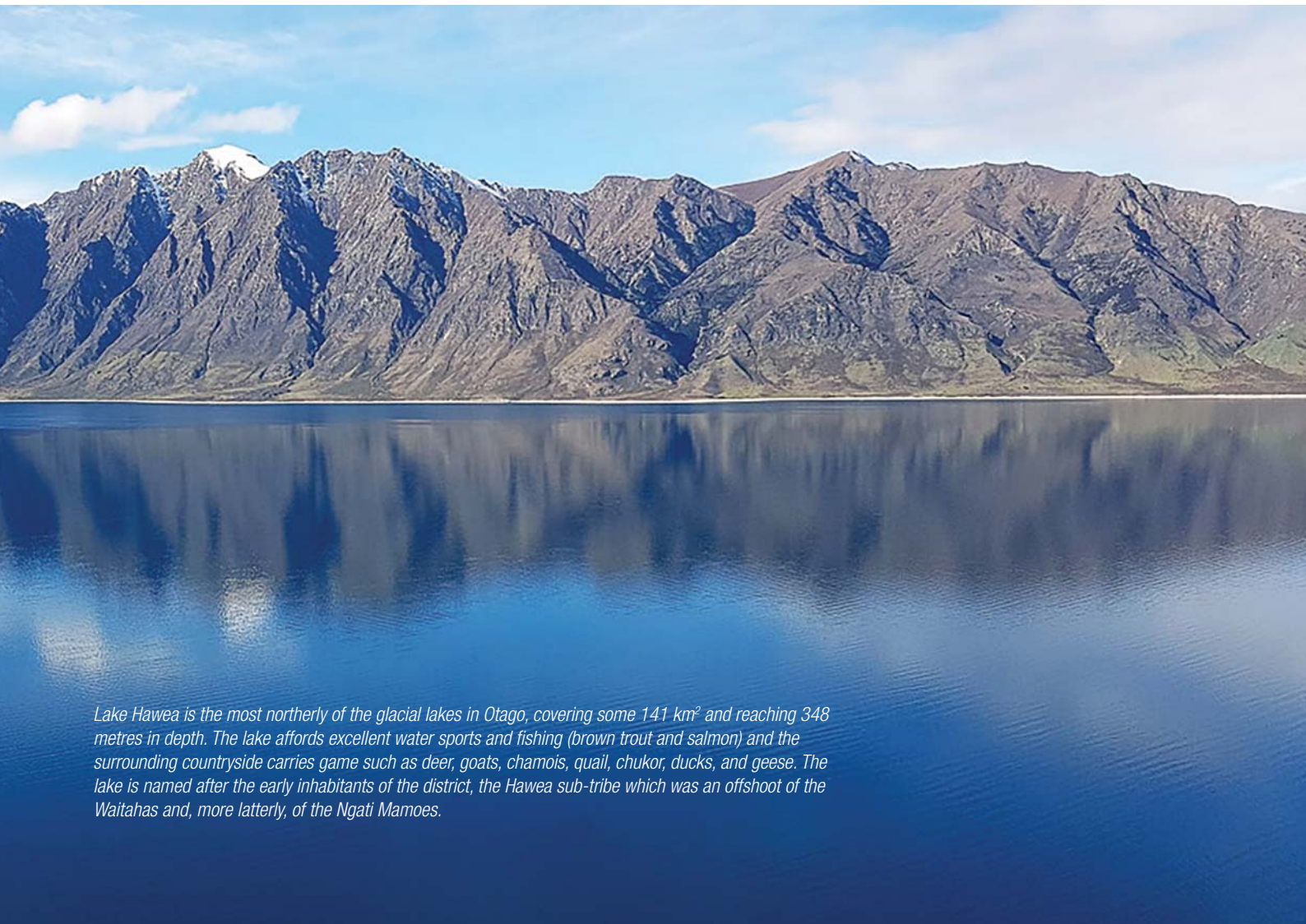

Lake Hawea is the most northerly of the glacial lakes in Otago, covering some 141 km² and reaching 348 metres in depth. The lake affords excellent water sports and fishing (brown trout and salmon) and the surrounding countryside carries game such as deer, goats, chamois, quail, chukor, ducks, and geese. The lake is named after the early inhabitants of the district, the Hawea sub-tribe which was an offshoot of the Waitahas and, more latterly, of the Ngati Mamoos.



TEKAPO

- 0% upward light
- Suitable for both commercial and residential use
- Warm white output for reduced sky glow
- Powder-coated cast alloy, tempered glass

12W

Product Code	Black	LHT1113
	White	LHT1114
LED Colour	3000K	
Luminous Flux	900 lm	
IP Rating	IP54	
Dimensions	162mm (A)	192mm (B) 60mm (C)

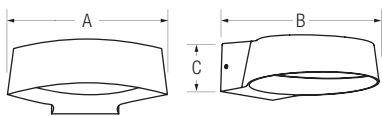

PUKAKI

- Modern design for modern decor
- All weather construction
- Use over doorways and access areas
- Powder-coated cast alloy, UV-stabilised polycarbonate

10W

Product Code	Anthracite	LHT1111
	White	LHT1112
LED Colour	3000K	
Luminous Flux	460 lm	
IP Rating	IP65	
Dimensions	125mm (A) 50mm (B)	137mm (C)

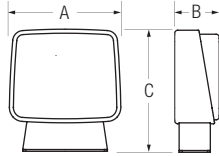

HAWEA

- Extra heavy duty construction
- Up/down light output
- Residential and commercial use
- Powder-coated cast alloy, UV-stabilised polycarbonate

7W

Product Code	Anthracite	LHT1119
	White	LHT1120
LED Colour	3000K	
Luminous Flux	170 lm	
IP Rating	IP65	
Dimensions	175mm (A) 64 mm (B)	83mm (C)



13W

Product Code	Anthracite	LHT1121
	White	LHT1122
LED Colour	3000K	
Luminous Flux	600 lm	
IP Rating	IP65	
Dimensions	248mm (A) 70mm (B)	115mm (C)

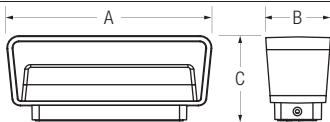

WAKATIPU

- Popular European styling
- Angled face for wider coverage
- Patios and pathways in commercial and residential spaces
- Powder-coated cast alloy, UV-stabilised polycarbonate

7W

Product Code	Anthracite	LHT1115
	White	LHT1116
LED Colour	3000K	
Luminous Flux	235 lm	
IP Rating	IP65	
Dimensions	180mm (A) 114mm (B)	65mm (C)



13W

Product Code	Anthracite	LHT1117
	White	LHT1118
LED Colour	3000K	
Luminous Flux	360 lm	
IP Rating	IP65	
Dimensions	250mm (A) 123mm (B)	74mm (C)

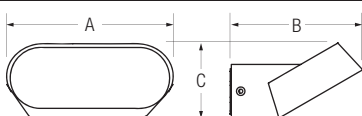



WANAKA

- Sleek design creating exceptional styling
- Zero frame lens
- Soft warm white output for patios and balconies
- Powder-coated cast alloy, UV-stabilised polycarbonate

13W

Product Code	Anthracite	LHT1109
	White	LHT1110
LED Colour	3000K	
Luminous Flux	690 lm	
IP Rating	IP65	
Dimensions	270mm (A)	58mm (B) 100mm (C)

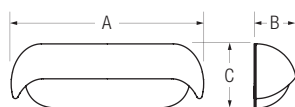

UP/DOWN LIGHTS

VERSATILE FACADE LIGHTING



AORAKI



TARAWERA



RUAPEHU



TUTOKO



TONGARIRO



Aoraki / Mount Cook is the highest mountain in New Zealand. In legend, Aoraki (Cloud in the Sky) was one of the sky father's four sons who had gone off in a canoe to explore the southern ocean. Intending to return home their canoe capsized turning into the land formation now known as the South Island. Aoraki and his brothers clambered on to the high side and were turned to stone to become the Southern Alps. They are still there today with Aoraki, the highest peak (Mount Cook) surrounded by his brothers who are the next highest peaks. Abel Tasman's crew decided to name the peak in English; "Mount Cook" in honour of Captain James Cook.



RUAPEHU

- Contemporary and robust design
- High quality optics - 38°
- Low glare direct output
- Powder-coated cast alloy, tempered glass

2 x 6W

Product Code	LHT1131
LED Colour	3000K
Luminous Flux	950 lm
IP Rating	IP65
Dimensions	178mm (A) 94mm (B) Ø 63mm (C)

2 x 12W

Product Code	LHT1133
LED Colour	3000K
Luminous Flux	1550 lm
IP Rating	IP65
Dimensions	280mm (A) 171mm (B) Ø 108mm (C)

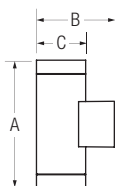

TUTOKO

- Subtle side light effect
- Durable, water and dustproof
- Excellent patio and entrance lighting
- Powder-coated cast alloy, UV-stabilised polycarbonate

2 x 6W

Product Code	LHT1146		
LED Colour	3000K		
Luminous Flux	950 lm		
IP Rating	IP65		
Dimensions	178mm (A)	97mm (B)	63mm (C)

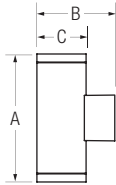

TONGARIRO

- Subtle side light effect
- Durable, water and dustproof
- Excellent patio and entrance lighting
- Powder-coated cast alloy, UV-stabilised polycarbonate

2 x 6W

Product Code	LHT1129		
LED Colour	3000K		
Luminous Flux	490 lm		
IP Rating	IP65		
Dimensions	175mm (A)	94mm (B)	Ø 63mm (C)

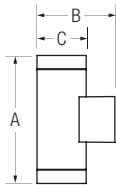

AORAKI

- Subtle sidelight effect
- Durable, water and dustproof
- Warm white light creates a welcoming ambient
- Powder-coated cast alloy, UV-stabilised polycarbonate

2 x 3W

Product Code	LHT1127		
LED Colour	3000K		
Luminous Flux	340 lm		
IP Rating	IP65		
Dimensions	142mm (A)	62mm (B)	54mm (C)

2 x 8W

Product Code	LHT1128		
LED Colour	3000K		
Luminous Flux	850 lm		
IP Rating	IP65		
Dimensions	220mm (A)	70mm (B)	57mm (C)

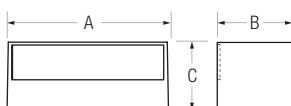



TARAWERA

- Low glare direct output
- Robust and compact construction
- Creates beautiful grazing effect on facades
- Powder-coated cast alloy, tempered glass

2 x 3W

Product Code	LHT1135		
LED Colour	3000K		
Luminous Flux	450 lm		
IP Rating	IP65		
Dimensions	142mm (A)	62mm (B)	47mm (C)

2 x 8W

Product Code	LHT1136		
LED Colour	3000K		
Luminous Flux	1000 lm		
IP Rating	IP65		
Dimensions	220mm (A)	69mm (B)	45mm (C)

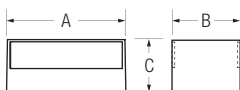

DOWNLIGHTERS

VERSATILE FACADE LIGHTING



TARAWERA



RUAPEHU



TUTOKO



TONGARIRO



Ruapehu, the largest active volcano in New Zealand, is the highest point in the North Island and has three major peaks: Tahurangi (2,797 m), Te Heuheu (2,755 m) and Paretetaitonga (2,751 m). The deep, active crater is between the peaks and fills with water between major eruptions, being known as Crater Lake (Te Wai a-moe). The name Ruapehu means "pit of noise" or "exploding pit".

RUAPEHU

- Contemporary and robust design
- High quality optics - 38°
- Low glare direct output
- Powder-coated cast alloy, tempered glass

7W - ZERO UPLIGHT

Product Code	LHT1132		
LED Colour	3000K		
Luminous Flux	500 lm		
IP Rating	IP65		
Dimensions	120mm (A)	94mm (B)	Ø 63mm (C)

12W - ZERO UPLIGHT

Product Code	LHT1134		
LED Colour	3000K		
Luminous Flux	810 lm		
IP Rating	IP65		
Dimensions	190mm (A)	171mm (B)	Ø 108mm (C)



TUTOKO

- Subtle side light effect
- Durable, water and dustproof
- Excellent patio and entrance lighting
- Powder-coated cast alloy, UV-stabilised polycarbonate

7W - ZERO UPLIGHT

Product Code	LHT1145		
LED Colour	3000K		
Luminous Flux	500 lm		
IP Rating	IP65		
Dimensions	120mm (A)	97mm (B)	63mm (C)



TONGARIRO

- Subtle side light effect
- Durable, water and dustproof
- Excellent patio and entrance lighting
- Powder-coated cast alloy, UV-stabilised polycarbonate

7W

Product Code	LHT1130		
LED Colour	3000K		
Luminous Flux	275 lm		
IP Rating	IP65		
Dimensions	120mm (A)	94mm (B)	Ø 63mm (C)

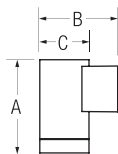

TARAWERA

- Low glare direct output
- Robust and compact construction
- Creates beautiful grazing effect on facades
- Powder-coated cast alloy, tempered glass

12W - ZERO UPLIGHT

Product Code	LHT1137		
LED Colour	3000K		
Luminous Flux	1550 lm		
IP Rating	IP65		
Dimensions	220mm (A)	72.5mm (B)	32mm (C)

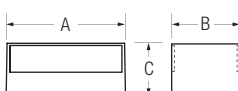

LED STEPLIGHTS

NON-INVASIVE PATHWAY AND PATIO LIGHTING



WAITOMO

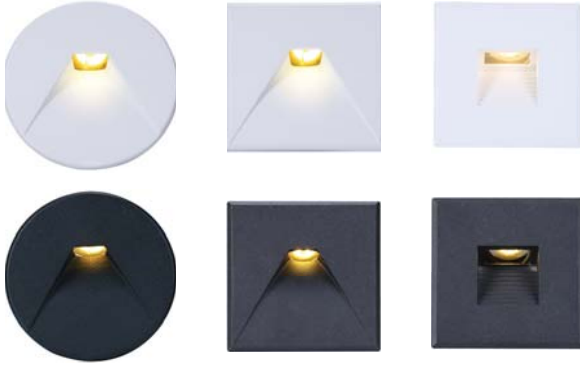

RUAKURI



WAITOMO

- 0% upward light
- Select LED colour temperature to suit location
- Powder-coated cast alloy
- Flush box for solid walls included



3W LED STEPLIGHT - ROUND FAN

Product Code	Black	LHT1148
	White	LHT1149
LED Colour Selectable	3000K, 4000K, 6000K	
Luminous Flux (approx)	120 lm	
IP Rating	IP44	
Dimensions	Ø 85mm (A)	54mm (B)



3W LED STEPLIGHT - SQUARE FAN

Product Code	Black	LHT1150
	White	LHT1151
LED Colour Selectable	3000K, 4000K, 6000K	
Luminous Flux (approx)	120 lm	
IP Rating	IP44	
Dimensions	85mm (D)	57mm (E) 85mm (F)



3W LED STEPLIGHT - SQUARE TIER

Product Code	Black	LHT1152
	White	LHT1153
LED Colour Selectable	3000K, 4000K, 6000K	
Luminous Flux (approx)	120 lm	
IP Rating	IP44	
Dimensions	85mm (G)	57mm (H) 85mm (I)

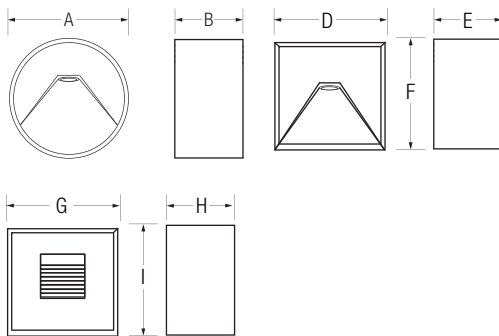

RUAKURI

- 0% upward light
- Powder-coated cast alloy
- Flush box for solid walls included

4W LED STEPLIGHT - LINEAR

Product Code	LHT1154
LED Colour	3000K, CR180
Luminous Flux	130 lm
IP Rating	IP65
Dimensions	160mm (A) (B) 66mm (C) 73mm (D)



10W LED STEPLIGHT - LINEAR

Product Code	LHT1155
LED Colour	3000K, CR180
Luminous Flux	380 lm
IP Rating	IP65
Dimensions	280mm (D) 66mm (E) 73mm (F)

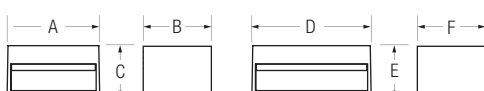
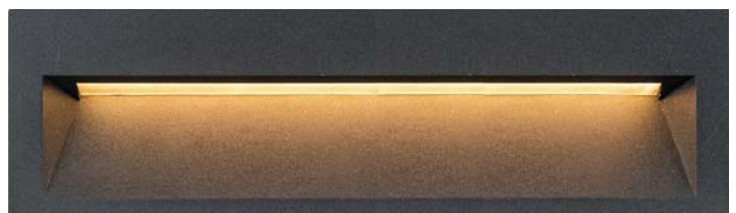

BOLLARDS

QUALITY SOLUTIONS FOR ACCESSWAYS AND PATHS

ESYLUX®





ESYLUX

ALVA

- High grade construction protects against sea air
- Suitable for path, forecourt, driveway or green area lighting
- Powder-coated cast alloy

7W CLEAR

Product Code	3K	Anthracite	LHT1006
	4K	Anthracite	LHT1009
		White	LHT1008
LED Colour and Luminous Flux	3000K	530 lm	
	4000K	560 lm	
IP Rating	IP65		
Rated Life	L70B10 = 105,000hrs		
Dimensions	700mm (A)	Ø 100mm (B)	

7W MILKY

Product Code	3K	Anthracite	LHT1010
	4K	Anthracite	LHT1012
LED Colour and Luminous Flux	3000K	400 lm	
	4000K	460 lm	
IP Rating	IP65		
Rated Life	L70B10 = 105,000hrs		
Dimensions	700mm (A)	Ø 100mm (B)	

Also available in larger 16 watt models for commercial and public spaces



SENSORS

PERFECT PARTNERS FOR SECURITY AND SAFETY



ESYLUX®

DEFENSOR



**DEFENSOR
TWILIGHT SWITCH**



TRINITY



MD-W



RC 230i



**SMART
SENSE**



**COMPACT
MINI**

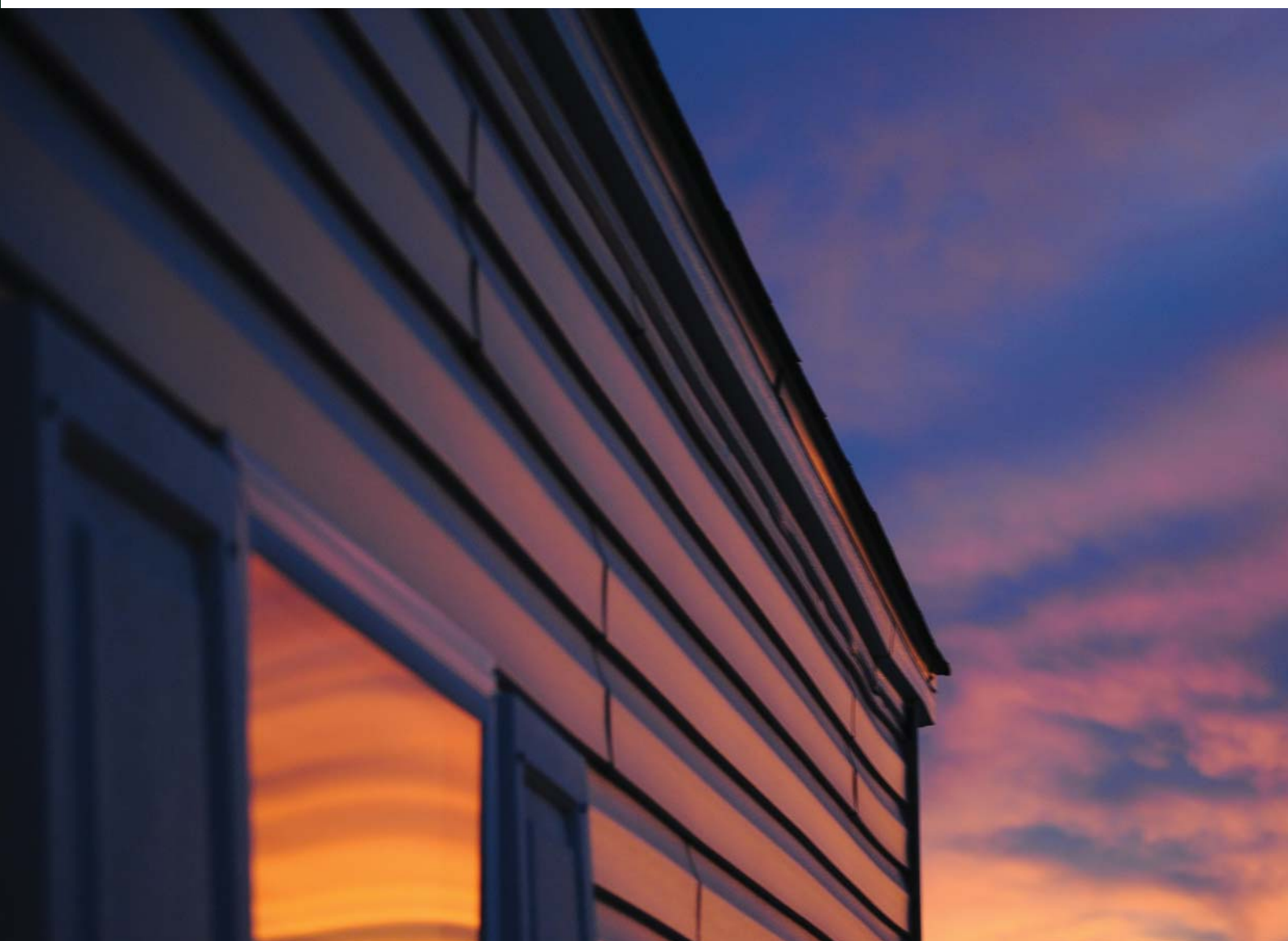



DEFENSOR

- Time dependent operating modes
- Run-on time on direction of movement
- Intelligent protection against vandalism and sabotage
- Zero cross switching to protect relays
- UV-stabilised polycarbonate

230° (2 x 115°)

Product Code	Anthracite	LHT1138
	White	LHT1139
Detection (adjustable)	Horizontal	230° (2 x 115°)
Range	Diagonal	Ø 40m
	Head-on	Ø 10m
Time On Adjustable		1 - 240 mins
Max. Switching	Resistive	2300W
	LED	600W
IP Rating		IP55

ESYLUX•



DEFENSOR TWILIGHT SWITCH

- Reliable and discreet safety
- Ambient lighting dependent switching
- Zero cross switching
- Time dependent operating modes

2300W

Product Code	Timer	LHT1141
	No Timer	LHT1140
Ambient Light Detection		2 - 500 lux
Ambient Temperature		-25°C - 50°C
Impact Resistance		IK07
IP Rating		IP55



MD-W 200°

- Blends in harmoniously with design of outer facades
- Optimised for controlling LED lights in outdoor areas
- Individual fields of detection for two zones
- UV-stabilised polycarbonate

MOTION DETECTION - 200°

Product Code	Black	LHT0291
	White	LHT0292
Detection (adjustable)		200° (2 x 100°)
Range	Diagonal	Ø 20m
	Head-on	Ø 10m
Time on Adjustable		15 sec - 16 min
Max. Switching	Resistive	2300W
	LED	600W
IP Rating		IP55



COMPACT MINI

- Practically invisible due to trimless compact size
- No remote electronics required
- Instant operation with factory settings
- UV-stabilised polycarbonate

MOTION DETECTION - 360°

Range	Switching	Max. Switching	Cut-out Size	IP Rating	Product Code
6m	ON/OFF	170W LED	Ø 20mm	IP65	LHT0523
8m	ON/OFF	600W LED	Ø 25mm	IP55	LHT0307
12m	ON/OFF	600W LED	Ø 25mm	IP55	LHT0524



PRESENCE DETECTION - 360°

Range	Switching	Max. Switching	Cut-out Size	IP Rating	Product Code
6m	ON/OFF	170W LED	Ø 20mm	IP65	LHT0525
8m	ON/OFF	600W LED	Ø 25mm	IP55	LHT0526
	Slave		Ø 25mm	IP55	LHT0529
12m	ON/OFF	600W LED	Ø 25mm	IP55	LHT0527

Also available for 12V DC, 12-36V AC/DC, DALI and KNX

RC 230i

- Wall or ceiling mounting
- High level of safety with 360° creep alert
- Zero-crossing switching to protect relays with high inrush
- UV-stabilised polycarbonate

230° (2 x 115°)

Product Code	Black	LHT0318
	White	LHT0319
Detection (adjustable)		230° (2 x 115°)
Range	Diagonal	Ø 40m
	Head-on	Ø 16m
Max. Switching	Resistive	2300W
	LED	600W
IP Rating		IP54



Also available for 12-36V AC/DC and KNX



TRINITY 180°

- Scrolling LED as intruder deterrent
- Integral 16A relay for switching
- UV-stabilised polycarbonate

TRINITY 180°

Product Code	Black	LHT0238
	White	LHT0239
Detection	180° Forward	
Range	10m	
Time On Adjustable	5 sec-15 min	
Max. Switching	Resistive	3000W
	LED	110W
IP Rating	IP55	



SMART SENSE 180°

- Wall or ceiling mount
- Large accessible wiring box
- Integral 12A relay for switching
- UV-stabilised polycarbonate

SMART SENSE 180°

Product Code	Black	LHT0119
	White	LHT0120
Detection	180° Forward	
Range	12m	
Time On Adjustable	5 sec-5 min	
Max. Switching	Resistive	2000W
	LED	110W
IP Rating	IP55	



SPOTLIGHTS & FLOODLIGHTS



INTELLIGENT LIGHTING FOR SECURITY AND SAFETY

SENSOR LED MAX



ECOSPOT SELECT



LED ECOSPOT



TRINITY LED



ROBO LED



CHAMELEON



REFLECT LED



FLOOD LED





SENSOR LED & SENSOR LED MAX

- Compact construction for discrete use
- Wall or ceiling mount
- High weatherproof rating
- UV-stabilised polycarbonate

SENSOR LED

Product Code	2 x 4W PIR	Black	LHT1081
		White	LHT1082
	2 x 8W PIR	Black	LHT0269
		White	LHT0270
Detection	140° Forward		
Range	8m		
Time On Adjustable	30 sec-6 min		
LED Colour	3100K		
Luminous Flux	2 x 4W	550 lm	
	2 x 8W	1200 lm	
Beam Angle	95°		
IP Rating	IP55		



ECOSPOT SELECT

- Lamp colour selectable
- Wall or ceiling mount
- Backlight restricted optics
- UV-stabilised polycarbonate



ECOSPOT SELECT

Product Code	2 x 10W PIR	Black	LHT1054
		White	LHT1055
Detection			150°
Range			10m
Time On Adjustable			10 sec-4 min
LED Colour & Luminous Flux		3000K	1800 lm
		4000K	2000 lm
		5000K	2000 lm
Pan/Tilt			Yes
IP Rating			IP54



Also available without sensor in twin or single models as below

ECOSPOT SELECT

Product Code	2 x 10W	Black	LHT1056
		White	LHT1057
1 x 10W			
Product Code	1 x 10W	Black	LHT1058
		White	LHT1059



LED ECOSPOT

- Wall or ceiling mount
- Extra wide beam optics
- Cast alloy, UV-stabilised polycarbonate

LED ECOSPOT

Product Code	2 x 8W PIR	Black	LHT0244
		White	LHT0250
Detection			180°
Range			12m
Time On Adjustable			10 sec-4 min
LED Colour			3500K
Luminous Flux			1440 lm
Beam Angle			105°
Pan/Tilt			Yes
IP Rating			IP44



Also available without sensor in twin or single models as below

LED ECOSPOT

Product Code	2 x 8W	Black	LHT0248
		White	LHT0249

LED ECOSPOT

Product Code	1 x 8W	Black	LHT0246
		White	LHT0247





TRINITY LED

- Scrolling LED as intruder deterrent
- Auto sensor, manual and timer modes
- Wide beam high output twin 12W LED
- Cast alloy, UV-stabilised polycarbonate

TRINITY LED

Product Code	2 x 12W PIR	Black	LHT0331
		White	LHT0332
Detection		3m	180°
		12m	80°
Range		up to 12m	
Auto Time On Adjustable		5 sec-7 min	
LED Colour		5500K	
Luminous Flux		1600 lm	
Beam Angle		105°	
IP Rating		IP44	



ROBO LED

- Motorised light follows movement in the detection zone
- PIR sensor for system efficiency
- Cover much larger areas with less fittings
- Cast alloy, UV-stabilised polycarbonate

18W

Product Code	LHT1083
Detection	270°
Range	10m
Time On (fixed)	3 min
LED Colour	4000K
Luminous Flux	1100 lm
Motorised Head Pan	±90°
IP Rating	IP44



REFLECT LED

- Rear projection technology
- Switchable PIR detect or dusk/dawn operation
- Extruded alloy, UV-stabilised polycarbonate

REFLECT LED

Product Code	12W	Black	LHT0271
		White	LHT0272
	12W PIR	Black	LHT0277
		White	LHT0273
	20W	Black	LHT0274
		White	LHT0280
	20W PIR	Black	LHT0275
		White	LHT0276
	26W PIR	Black	LHT0281
		White	LHT0282
Detection	120° Forward		
Range	10m		
Time On Adjustable	5 sec-10 min		
LED Colour	5700K		
Luminous Flux &	12W	500 lm	105°
Beam Spread	20W	1000 lm	110°
	26W	1500 lm	110°
Dusk Control	2-2000 Lux Adjustment		
IP Rating	PIR	IP54	
	Non-PIR	IP55	



Also available without sensor in single or twin models

FLOOD LED

- Best choice for commercial and industrial applications
- Optimised thermal fins for heat dissipation
- Long life components
- Cast alloy, tempered glass

FLOOD LED

Product Code	30W	LHT0214
	50W	LHT0215
LED Colour	5700K	
Luminous Flux	30W	2350 lm
	50W	4250 lm
Beam Spread	110°	
Rated Life	L70 B50 = 56,000 hrs	
Cable (fitted)	1800mm	
IP Rating	IP65	





CHAMELEON

- Select LED colour temperature to suit application
- 8 step dimming with remote controller (included)
- Grouping capable for synchronised operation
- Powder-coated cast alloy, tempered glass

20W

Product Code	Black	LHT1096
	White	LHT1097
LED Colour	3000K / 4000K / 5000K	
Luminous Flux (adjustable)	130-1500 lm	
Cable (fitted)	900 mm	
IP Rating	IP65	



LED Colour Selectable



Dim Control



10-100%





Simx Lighting
PO Box 14347, Panmure, Auckland NZ
e: lighting@simx.co.nz | **w:** www.simx.co.nz | **p:** +64 9 259 1660

Specifications are subject to change without notice

PUB1581 2103