

designersplash

Colour Your World



INSTALLATION GUIDE
VERSION 2.2 | FEBRUARY 2024

PSP MATERIALS
PRODUCTS
SOLUTIONS

TABLE OF CONTENTS

1.0	GENERAL INFORMATION	1
1.1	Introduction	1
1.2	Important Documents	1
1.3	Controlled Documents	1
2.0	DESIGN	1
2.1	Building Consent Application	1
2.2	Specification	1
2.3	Product Substitution	1
3.0	PLAN THE LAYOUT	2
4.0	PREPARATION	3
4.1	Safety and Tools	3
4.2	Handling and Storage	3
4.3	Install Plumbing in Wet Areas	3
4.4	Prepare Substrate	3
4.5	Cut Aluminum Trims	4
4.6	Cut DesignerSplash	4
4.7	Create a Dry Layout	4
5.0	INSTALLATION	5
5.1	Install Aluminum Trims	5
5.2	Provide Electrical Earthing	5
5.3	Install DesignerSplash	5
5.4	Install Fixtures	6
5.5	Complete the Installation	6
6.0	CARE AND MAINTENANCE	6

1.0 GENERAL INFORMATION

1.1 Introduction

DesignerSplash is a 4mm thick aluminium composite panel intended for use as an internal, impervious lining. The panel comprises 0.5mm aluminium skins and a 3mm thick core of high-density mineral fiber. DesignerSplash is supplied in a range of sizes and colors.

The panels are installed with a Modified Silicone (MS) Polymer High Tack Adhesive and Aluminium Finishing Trims - available in Anodised Silver and Powder-coated Black finishes.

1.2 Important Documents

In addition to this guide, PSP also supply the following documents to assist with DesignerSplash specification, installation, and maintenance:

- The Minor Variation form (where a consented internal lining is to be substituted with DesignerSplash)
- The BPIR Declaration
- Warranty - refer to PSP Terms & Conditions [Paragraph 16. Warranties and Liability](#)

1.3 Controlled Documents

All documents are controlled. It is important to ensure that the current documents are always used. For documents, refer to www.psp.co.nz.

2.0 DESIGN

2.1 Building Consent Application

Where the specification of DesignerSplash is part of a building consent application, the following documentation must be submitted:

- This Installation Guide
- The BPIR Declaration

2.2 Specification

DesignerSplash is only intended for internal use and for vertical installation.

Substrate

The substrate, to which the DesignerSplash will be adhered, must be fixed to a structure that complies with the building code or to an existing structure that has the equivalent stiffness of the framing provisions for NZS 3604:2011.

DesignerSplash Installation

DesignerSplash is to be fixed to the substrate with an MS Polymer High Tack Adhesive and finished with an MS Polymer Sealant. Ensure that the adhesive/sealant is suitable for the substrate and the DesignerSplash. PSP supplies finishing trims.

2.3 Product Substitution

Where DesignerSplash is to be used as a substitute for the consented product, the following documentation must be supplied to the building inspector before installation of the DesignerSplash:

- The Minor Variation Form
- This Installation Guide
- The BPIR Declaration

3.0 PLAN THE LAYOUT

Planning the layout at the beginning of the project will ensure that the final installation of the panels will create the desired look and feel. It will also ensure less wastage and faster installation.

Note: Ensure that your plan is easy to follow, as it will be used at the dry layout stage.

REMEMBER:

- * DesignerSplash is only intended for internal use; for installation on vertical surfaces.
- * When used as a kitchen splashback, the panel must have a minimum 20mm setback from the rear edge of all hobs (incl. electric, induction, and gas). For all gas cooktops, a clearance of 110 mm from the edge of the open-flame gas burner is required.

ALL COOKTOPS

Minimum Clearance - 20mm

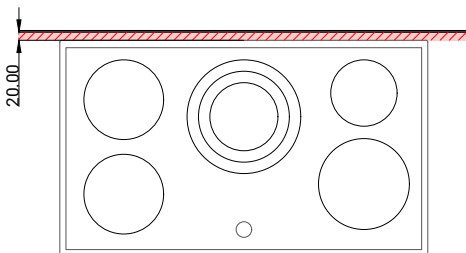

GAS COOKTOPS

Minimum Clearance - 110mm

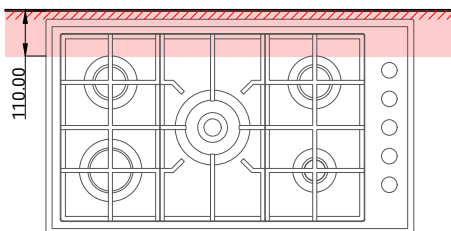

STEP 1

Consider the panel dimensions that would best suit your DesignerSplash application.

- **750mm** x 3100mm, 750mm x 2100mm, 750mm x 900mm, 750mm x 600mm,
- **1550mm** x 3100mm, 1550mm x 2100mm

STEP 2

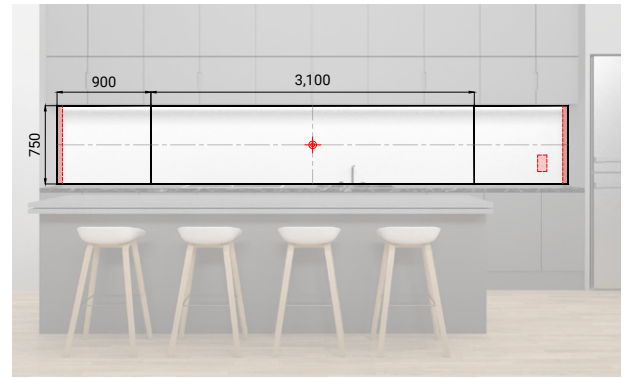

For each wall:

- Measure and mark fixtures that will affect the installation, especially electrical fixtures.
- Determine the center point of the wall; this represents the mid-point of the layout.
- The panels will be positioned from the mid-point. Take note of panels that need to be cut, ensuring allowances for the trim installation.

Note: DesignerSplash has a colour on both sides, ensure the correct colour faces outwards. Before applying adhesive, remove the protective film on the back of the panel only.

STEP 3

Determine trim locations and required lengths.

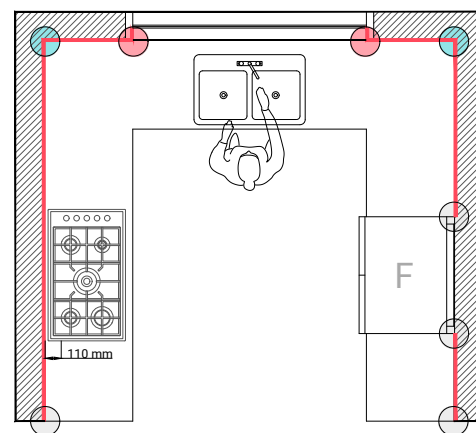

KEY	VERTICAL COMPONENT
	DesignerSplash PANELS
	WALL COMPOSITION
	EXTERNAL CORNER TRIM
	INTERNAL CORNER TRIM
	EDGE TRIM

4.0 PREPARATION

4.1 Safety and Tools

Keep Safe

Follow simple health and safety practices:

- Create a safe working environment that is well organised, tidy, and clear of obstructions.
- Always ensure PPE is worn (eye protection, gloves, dust mask, and safety footwear).
- Always operate tools and equipment strictly in accordance with the supplier's manuals.
- Regularly service tools and equipment to ensure efficient and correct operation.
- Where possible, work in an area that is well ventilated or where mechanical dust extraction is possible. This is especially important if cutting or drilling.
- Where working at height, ensure the correct selection and use of safety gear.

For further information, refer to

www.worksafe.govt.nz and, in particular:

- WorkSafe. [July 2018] Small Construction Sites, The Absolutely Essential Health and Safety Toolkit.
- WorkSafe. [December 2016] Health and Safety at Work, Quick Reference Guide.

Skills and Tools

Competent DIYer skills and standard carpentry tools are required to install DesignerSplash. The following tools will help to simplify installation:

- | | |
|----------------------------|----------------|
| • Drill + Speed Drill Bits | • Table Saw |
| • Scribing Knife | • Circular Saw |
| • Utility Knife | • Hole Saw |
| • Scoring Knife | • Plunge Saw |
| • Soft-faced Mallet | • Jig Saw |
| • Cartridge Gun | • Hack Saw |



Electric Shock Hazard: An electrician may be required where there is risk of touch voltage.

Additional Products

To install DesignerSplash, the following products are required.

- **ALUMINIUM FINISHING TRIMS** - To ensure the finish of the installation is durable and waterproof. Trims are supplied with options in silver and black.
- **ADHESIVE** - MS Polymer Adhesive compatible with DesignerSplash and substrate. Preferably a High Tack Polymer for instant grab during install.

Tip: VHB (double-sided) Tape may be helpful for fixing of DesignerSplash where the initial hold is of concern while the adhesive cures.

- **SEALANT** - MS Polymer Sealant compatible with DesignerSplash.

4.2 Handling and Storage

- * Take care when transporting, handling, and storing DesignerSplash to prevent damage.
- * DesignerSplash is supplied wrapped in a adhered protective film. Before installation, remove the film on the back of the panel, then remove the front film prior to using sealant.
- * Transport and store the panels flat. Cover in a well-ventilated area out of direct sunlight. Make sure that the panels are well supported to avoid distortion.
- * Do not stack panels if they are wet.

4.3 Install Plumbing in Wet Areas

It is important to ensure that the waterproofing is not compromised when installing plumbing. Refer to the supplier of the plumbing fixtures or a plumber for instructions and advice.

BRANZ also covered this in BRANZ Build 157.

[December 2016] Penetrations in Wet Areas.

Refer to www.buildmagazine.org.nz/index.php/articles/show/penetrations-in-wet-areas.

4.4 Prepare Substrate

Ensure that the substrate is level, true, and fixed soundly to the framing. Check that the substrate surface is clean, dry, and free of dirt, grease, and other contaminants. Lightly sand or prime glossy surfaces to remove sheen.

4.5 Cut PSP Aluminium Trims

Cut Trims to Length

Review trim locations, considering vertical and horizontal applications.

Select the appropriate trim and proceed to measure, mark, and cut the necessary lengths.

Trims may be cut with a hack saw or circular saw with an aluminium blade.

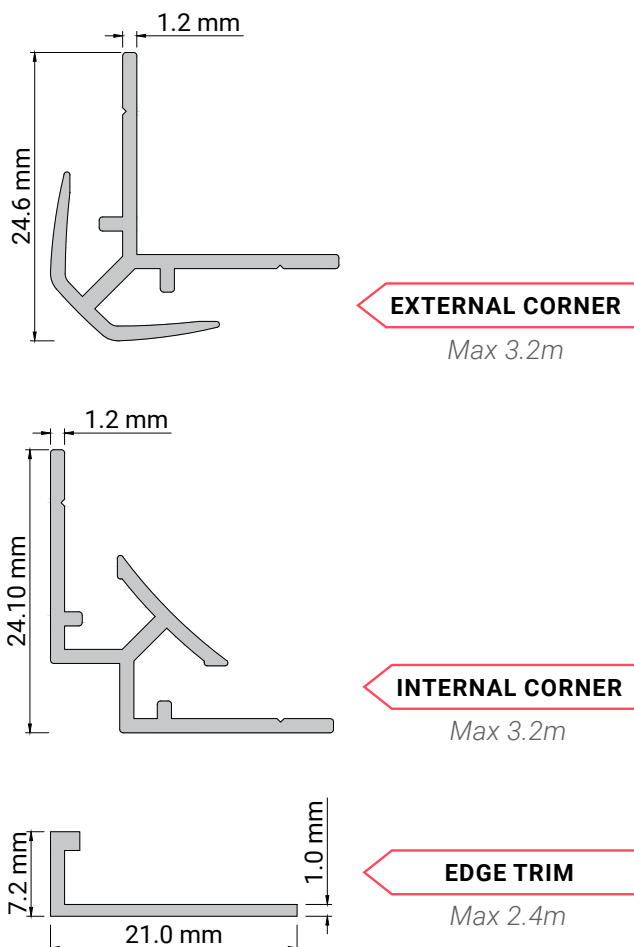

4.6 Cut DesignerSplash

Cut and Create Openings

Measure and mark on the panel where holes and cuts are required. Exercise caution to protect the panel from saw or jig saw-induced scratches.

DesignerSplash may be cut with:

- A Circular Saw (Aluminium Cutting Blade)
- A Fine-toothed Jig Saw (Aluminium Blade)
- Table Saw (Aluminium Carbide Blade)

Tip: Apply masking tape to the line of the cut to reduce the risk of chipping and to protect the surface of the DesignerSplash.

Circular Holes

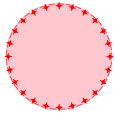
1. On the front or back side of the panel, mark the circular area to be removed. 
2. Utilise a hole saw or drill (3.5 - 5.0mm speed bit) to create a series of holes as close to each other as possible.
3. Push the waste material through and finish the opening with a utility knife or similar.

Rectangular Holes

1. On the front or back side of the panel, mark the rectangular area to be removed. 
2. Drill holes at the corners of the rectangle (15 - 18mm dia.) big enough to accommodate a fine-toothed jig saw blade.
3. Cut the opening with a jig saw.

4.7 Create a Dry Layout

The Dry Layout stage is important to ensure that the final placement of DesignerSplash is square and true.

It will highlight if adjustments are needed to walls that are out of square or if the DesignerSplash panels need to be trimmed because of wall, floor, or ceiling alignment.

5.0 INSTALLATION

5.1 Install Aluminium Trims

Follow the MS Polymer High Tack Adhesive supplier's instructions when installing the trims.



EXTERNAL & INTERNAL CORNER TRIMS

To install, apply a small bead of adhesive directly to the substrate corner or on the trim itself, then press it in place. Also apply a bead of sealant into each of the trim's channels to prevent water from reaching the substrate.

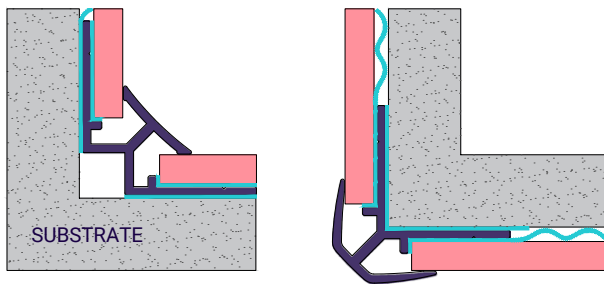

EDGE TRIM

Used in vertical and horizontal applications to finish the terminal end of panels and provide a finished look.

To install trim, apply a small bead of adhesive directly to the substrate or on the trim itself, then press it in place. Also apply a bead of adhesive into the trim's receiving channel.

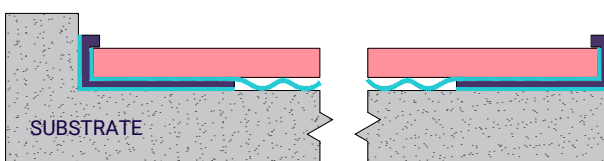

Tip: If necessary, use some masking tape to secure trim whilst the adhesive cures.

5.2 Provide Electrical Earthing

DesignerSplash features an aluminium face that is conductive of electricity. In instances involving contact with an electrical current (such as power points, light fittings, or wires), an earth connection may be required.

PSP recommends seeking advice from a registered electrician.

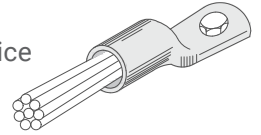

An electrician will install earthing using a crimp lug that connects to a bonding wire which runs down the back of the panels.

5.3 Install DesignerSplash

STEP 1

Before applying MS Polymer High Tack Adhesive, remove the protective film on the back of the DesignerSplash panel, and refer to the adhesive supplier's instructions.

STEP 2

For all panels, the adhesive should be applied (on the panel or directly to the wall) as a continuous 5 mm bead in a zig-zag pattern at 300 mm centres.

Tip: For the first panel, apply VHB tape in the voids to provide support whilst adhesive cures.

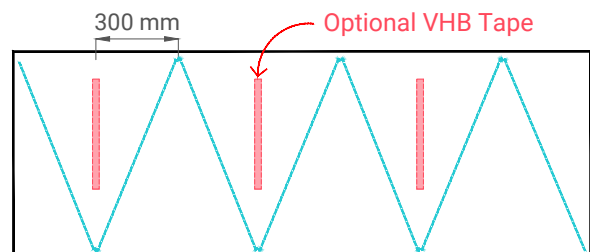

STEP 3

Apply even pressure across the panel and press it in place. Clean up any excess adhesive with a silicone remover.

STEP 4

Allow adhesive to dry for a few minutes and then peel off the protective film on the front of the DesignerSplash panel.

STEP 5

Line masking tape around corners/edges where PSP Aluminium Trims are not utilised.

Apply MS Polymer Sealant in the joint between the DesignerSplash and adjacent surface to avoid moisture penetration. Refer to the sealant supplier's instructions. Clean up any excess sealant with a silicone remover.

5.4 Install Fixtures

The DesignerSplash and adhesive are not strong enough to support shelves or other fixtures. "Stick on" fixtures are not recommended, as failure may cause damage to the DesignerSplash and substrate. It is best to install fixtures through to the framing.

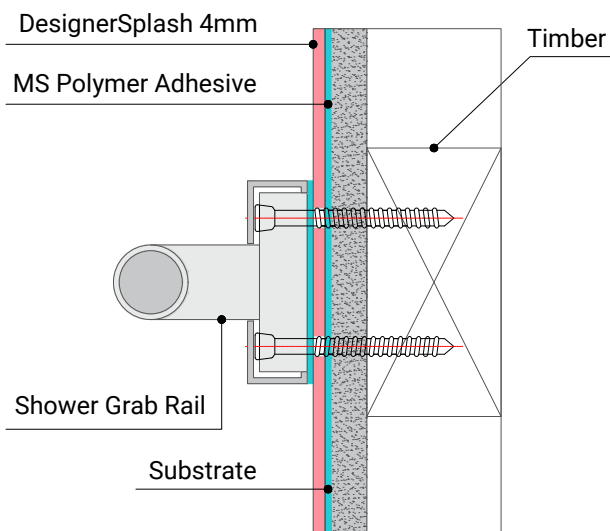

Where the panel is required to be waterproof, BRANZ recommends the following approach:
*Identify, mark, and predrill the fixing location.
Before inserting the fixing, fill with sealant.
Apply sealant to the back face of the plate or bracket before fixing through the DesignerSplash to the framing.*

For further information, refer to BRANZ Build 157.

[December 2016] Penetrations in Wet Areas.

[www.buildmagazine.org.nz/index.php/articles/show/penetrations-in-wet-areas.](http://www.buildmagazine.org.nz/index.php/articles/show/penetrations-in-wet-areas)

5.5 Complete the Installation

When the adhesive and silicone has dried and cured (as per the supplier's instructions), clean the DesignerSplash panels with warm soapy water (or natural alternative).

Tip: For a natural home-remedy cleaning option, use a mixture of 1 cup vinegar to 4 cups hot water.

6.0 CARE AND MAINTENANCE

DesignerSplash is fully washable and should be regularly cleaned. Use a sponge with warm soapy water to remove any dirt or grime.

Do not use abrasive substances or chloride-based products or solvents.