



**Oblique™
Weatherboard
Vertical
Installation to
Hardie™ 40mm
structural
horizontal
cavity batten**

Technical Specification

October 2022 New Zealand



We value your feedback!

To continue with the development of our products and systems, we value your input. Please send any suggestions, including your name, contact details, and relevant sketches to:

Ask James Hardie™
literaturefeedback@jameshardie.co.nz

Make sure your information is up to date

When specifying or installing Hardie™ fibre cement products, ensure that you have the current manual. Additional installation information, warranties and warnings are available at www.jameshardie.co.nz or **Ask James Hardie™** on 0800 808 868.

Contents

1	Product Overview	4	6	Preparation	15
1.1	Product Information	4	6.1	RAB™ Board	15
1.2	Manufacturing and Classification	4	6.2	Cavity Closure/Vent Strip	15
2	Application	7	6.3	Hardie™ 40mm Structural Horizontal Cavity Batten	15
2.1	Application	7	6.4	Flashings	16
2.2	Scope	7	7	Installation	17
2.3	Details	7	7.1	General	17
2.4	Specific Design	7	7.2	Fastener	17
3	Compliance	8	7.3	Fastener Durability	17
3.1	Compliance	8	7.4	Vertical Joint	18
4	Design	8	7.5	Horizontal Joint	18
4.1	Responsibility	8	7.6	Drainage Joint	18
4.2	Site and Foundation	9	7.7	External Corner	18
4.3	Clearances	9	7.8	Internal Corner	18
4.4	Moisture Management	9	8	Finishes	19
4.5	Structure	9	8.1	Preparation	19
4.5.1	Timber Framing	9	8.2	Painting	19
4.6	Wind Pressures	10	8.3	Flexible Sealant	19
4.7	Structural Bracing	10	9	Care and Maintenance	20
4.8	Energy Efficiency	10	10	Details section index	21
4.9	Fire Rated Walls	10	Product Warranty	55	
4.10	Control of External Fire Spread	10			
4.11	Durability	10			
4.12	Alpine Regions	10			
5	Safe Working Practices	11			
5.1	Storage and delivery	13			
5.2	Tips for safe and easy handling of Oblique™ Weatherboard	14			

1 Product Overview

1.1 Product Information

Oblique™ Weatherboard installed as per this specification gives a vertical panelised masonry appearance. Oblique™ Weatherboard can be fixed to timber-framed external walls. A wide range of colours can be used, varying from light to dark.

Table 1

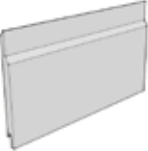
Oblique™ Weatherboard information					
Product	Description	Size (mm)			Code
		Thickness	Length	Width	
	Oblique™ Weatherboard A 14mm profiled weatherboard for residential cladding. Factory sealed on all six sides. Each weatherboard has a manila white colour primer applied on its face, which accepts a wide range of paint finishes.	14	2750	200 300	405322 405323
			4200	200 300	405320 405321

Note: All dimensions and masses provided are approximate only and are subject to manufacturing tolerances.

Oblique™ Weatherboard is manufactured in 14.0mm thickness and has a mass of 16kg/m² at EMC.

Oblique™ Weatherboard is defined as a Light Weight Wall Cladding (not exceeding 30kg/m²) as per NZS 3604.

1.2 Manufacturing and Classification

Oblique™ Weatherboard is an advanced lightweight cement composite cladding, manufactured using James Hardie formulation. Basic composition is Portland cement, ground sand, cellulose fibre and water. The product is easily identified by the name 'Oblique™ Weatherboard'.

Oblique™ Weatherboard is manufactured in Australia to Australian/New Zealand Standard AS/NZS 2908.2 'Cellulose-Cement Products' (ISO 8336 'Fibre-Cement Flat Sheet').

Oblique™ Weatherboard is classified Type A, Category 2 in accordance with AS/NZS 2908.2 "Cellulose-Cement Products".

For Safety Data Sheets (SDS) visit www.jameshardie.co.nz or Ask James Hardie™ on **0800 808 868**.

Table 2















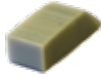

Accessories/tools supplied by James Hardie			
Accessories	Description	Size	Code
	Hardie™ 40mm Structural Horizontal Cavity Batten H3.1 Timber treated batten the cladding is fixed to	2700mm long	306077
	Hardie™ 14mm Trimline Joint Flashing Aluminium extrusion used behind cladding at horizontal joints.	3000mm long	305827
	Hardie™ Weatherboard Internal 'W' Corner Anodised aluminium extrusion used to create internal corners.	2750mm long 4000mm long	306220 306180
	Hardie™ 14mm Internal Corner Anodised aluminium extrusion used to create internal corners.	2700mm long	304871
	Hardie™ 14mm External Box Corner Anodised aluminium extrusion used to create external corners.	2750mm long 4000mm long	306160 305823
	Trimline Horizontal Jointer A jointer to cover the butt joint of Oblique Trimline Joint Flashing	100mm long	305871
	Trimline External Corner Jointer Joins Trimline Joint Flashing at an external corner		305870
	Trimline Internal Corner Jointer Joins Trimline Joint Flashing at an internal corner		305872
	Oblique™ 14mm Plug To fill recess in Oblique™ Weatherboard		306154
Tools			
	Hardie™ Blade Saw Blade Diamond tip fibre cement circular saw blade. Spacers not included.	184mm 254mm	300660 303375

Table 3

Accessories/Tools not supplied by James Hardie

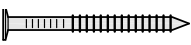
James Hardie recommends the following products for use in conjunction with Oblique™ Weatherboard and James Hardie rigid air barrier. James Hardie does not supply these products and does not provide a warranty for their use. Please contact component manufacturer for information on their warranties and further information on their products.

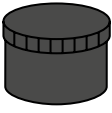
Product	Description
	<p>Flexible window opening flashing tape A flexible self-adhesive tape used in preparation of a window. Refer to the window installation section in this manual for more information. e.g. Protecto or Super-Stick by Marshall Innovation or 3M™ All Weather Flashing Tape 8067 by 3M™ Marshall Innovation: 0800 776 9727 3M™: 0800 474 787</p>
	<p>Flexible sealant Bostik® Seal N Flex-1®, Sikaflex® AT Facade, Sikaflex® MS or similar.</p>
	<p>40mm Vent Strip Moulding used as vermin proofing.</p>
	<p>50 x 2.87mm 'D' head nail or 50 x 2.87 RoundDrive nail (ring shank hot dipped galvanised/stainless steel) For fixing Oblique™ Weatherboard.</p>
	<p>75 x 3.06mm RoundDrive ring shank galv/ss nail (hot dipped galvanised or ring shank stainless steel) For fixing Hardie™ 40mm structural horizontal cavity battens to timber frame.</p>
	<p>80mm x 10g screw For fixing Hardie™ 40mm structural horizontal cavity battens to timber frame.</p>
	<p>Exterior grade filler CRC® ADOS® Builders Fill or similar two part filler to fill over nail holes</p>
	<p>Penetration Seal Thermakraft®: 0800 806 595 Marshall Innovations: 0800 776 9727</p>

2 Application

2.1 Application

Oblique™ Weatherboard can be fixed to timber framed external walls.

Specifiers

If you are a specifier or other responsible party for a project ensure that the information in this document is appropriate for the application you are planning and that you undertake specific design and detailing for areas which fall outside the scope of these specifications.

Installers

If you are an installer ensure that you follow the design, moisture management principles, associated figures and material selection provided by the designer and this Technical Specification. All of the details provided in this document must be read in conjunction with the project specification.

2.2 Scope

This specification covers the installation of Oblique™ Weatherboard fixed vertically over Hardie™ 40mm horizontal cavity battens on buildings that fall within the scope limitation of NZS 3604 and E2/AS1 of the New Zealand Building Code (NZBC).

2.3 Details

Various typical Oblique™ Weatherboard construction details are provided within this document. These details are available in dwg, dxf, jpg and pdf file format and can be downloaded from our website at www.jameshardie.co.nz.

All dimensions shown are in millimetres unless noted otherwise.

2.4 Specific Design

For use of Oblique™ Weatherboard on a specific design project that is outside the scope of this literature, the designer, architect or engineer must ensure that applicable clauses of the NZBC have been considered and a specific design has been undertaken.

3 Compliance

3.1 Compliance

Oblique™ Weatherboard installed vertically in accordance with this specification has been tested/assessed to demonstrate compliance with clauses E2, B1 and B2 of the NZBC.

Oblique™ Weatherboard Vertical Installation to Hardie™ 40mm structural cavity batten has a BRANZ Appraisal number 1232 (2022) to demonstrate compliance with the requirements of the NZBC. Please refer to our web site www.jameshardie.co.nz for a copy of the BRANZ appraisal.

4 Design

4.1 Responsibility

The specifier or other party responsible for the project must ensure that the information and details in this specification are appropriate for the intended application and that additional detailing is performed for specific design or any areas that fall outside the scope of this technical specification. For applications outside the scope of this literature and details, which are not provided herein, the architect, designer or engineer must undertake specific design and it should be ensured that the intent of their design meets the requirements of the NZBC.

All New Zealand Standards referenced in this document are current editions and must be complied with.

Make sure your information is up to date

When specifying or installing products from James Hardie, ensure that you have the current manual. Additional installation information, warranties and warnings are available at www.jameshardie.co.nz or Ask James Hardie™ on 0800 808 868.

James Hardie conducts stringent quality checks to ensure that any product manufactured falls within our quality spectrum. It is the responsibility of the builder to ensure that the product meets aesthetic requirements before installation. James Hardie will not be responsible for rectifying obvious aesthetic surface variations following installation.

4.2 Site and Foundation

The site on which the building is situated must comply with the NZBC Acceptable Solution E1/AS1 'Surface Water'. Foundation design must comply with the requirements of NZS 3604 'Timber-framed Buildings' or be as per specific engineering design. The grade of adjacent finished ground must slope away from the building to avoid any possibility of water accumulation in accordance with the NZBC requirements.

4.3 Clearances

The clearance between the bottom edge of the cladding and paved/unpaved ground must comply with section 9.1.3 of E2/AS1. The finished floor level must also comply with these requirements. These clearances must be maintained throughout the life of the building.

Oblique™ Weatherboard must overhang the bottom plate by a minimum of 50mm, as required by E2/AS1.

Oblique™ Weatherboard must maintain a minimum clearance of 100mm from paved ground, and 175mm from unpaved ground.

On roofs and decks, the minimum clearance must be 50mm.

Do not install external cladding such that it may remain in contact with water or ground.

4.4 Moisture Management

It is the responsibility of the specifier to identify moisture related risks associated with any particular building design.

Wall construction design must effectively manage moisture, considering both interior and exterior environments of the building, particularly in buildings that have a higher risk of wind driven rain penetration. The building should also be ventilated sufficiently to control moisture accumulation due to condensation, especially in artificially cooled/heated buildings.

Walls must include those provisions as required by the NZBC Acceptable Solution Clause E2/AS1. In addition, all wall openings, penetrations, junctions, connections, window sills, heads and jambs must incorporate appropriate flashings for waterproofing. The other materials, components and installation methods used to manage moisture in external walls, must comply with the requirements of relevant standards and the NZBC. For further guidance on designing for weathertightness, refer to BRANZ Ltd. and the Ministry of Business, Innovation and Employment (MBIE) updates on the following websites respectively, www.branz.co.nz and www.building.govt.nz.

In addition, the following issues must also be considered:

- Sealant must be installed where detailed in this literature
- Where the walls are higher than two storeys, it is necessary to provide a horizontal flashing at the second floor level to drain the cavity
- The installation of smoke chimneys, pipe penetrations and other fixtures etc. must not track moisture into the wall or restrict the drainage of moisture to the exterior

4.5 Structure

4.5.1 Timber Framing

Timber-framed buildings must either be in accordance with NZS 3604 (Timber-framed Buildings) or designed as per specific engineering design. For a building requiring a specific engineering design, the framing stiffness must be equivalent to, or more than, the stiffness requirements of NZS 3604.

For specific design projects, the timber framing must be designed in accordance with the requirements of NZS 3603 and AS/NZS 1170.

4.6 Wind Pressures

Oblique™ Weatherboard is suitable for use in wind zones up to and including EH as defined in NZS 3604.

4.7 Structural Bracing

Oblique™ Weatherboard installed as per this specification cannot be used to achieve any structural bracing. However, bracing can be achieved by using a rigid air barrier such as RAB™ Board or HomeRAB™ Pre-Cladding by James Hardie installed direct to framing instead of a flexible underlay or by using the Villaboard™ Lining bracing system on the internal face of the wall. Refer to the Bracing Design Manual by James Hardie for further information.

4.8 Energy Efficiency

External walls constructed as per this technical specification, using Linea Weatherboard cladding must use suitable bulk insulation to meet the minimum thermal insulation requirements as per Clause H1/AS1 'Energy Efficiency' of the NZBC.

4.9 Fire Rated Walls

A fire rating up to 60 minutes can be achieved when Oblique™ Weatherboard is used in conjunction with RAB™ Board and Oblique™ Weatherboard is installed to Hardie™ 40mm structural horizontal cavity batten.

Refer to the Fire and Acoustic Design Manual by James Hardie for further guidance on achieving fire ratings.

Oblique™ Weatherboard is suitable for use where 'non-combustible' materials are to be specified in external wall applications.

4.10 Control of External Fire Spread

Oblique™ Weatherboard material is classified as 'Type-A' as per Table C1.3 when tested to the requirements of Appendix C7.1.1 (b) of C/AS2 of the NZBC and is suitable for use where 'Non-Combustible Material' or 'Limited Combustibility Material' is required for use in buildings located anywhere in relation to the relevant boundary for building within the scope of C/AS1 or C/AS2.

4.11 Durability

Oblique™ Weatherboard, HomeRAB Pre-Cladding™ and RAB™ Board installed and maintained as per this technical specification will meet the durability requirement for cladding as per the NZBC clause B2 Durability.

Oblique™ Weatherboard is resistant to permanent moisture induced deterioration (rotting) and meets the requirements of the following tests in accordance with the AS/NZS 2908.2:

- Heat Rain (Clause 6.5)
- Water Permeability (Clause 8.2.2)
- Warm Water (Clause 8.2.4)
- Soak Dry (Clause 8.2.5)

4.12 Alpine Regions

In regions subject to freeze/thaw conditions, Oblique™ Weatherboard, HomeRAB Pre-Cladding™ and RAB™ Board must not be in direct contact with snow or ice build up for extended periods, e.g. external walls in alpine regions must be protected where snowdrifts over winter are expected.

These products meet the requirements of the AS/NZS 2908.2 Clause 8.2.3.

5 Safe Working Practices

WARNING - DO NOT BREATHE DUST AND CUT ONLY IN WELL VENTILATED AREA

Hardie™ fibre cement products contain sand, a source of respirable crystalline silica

May cause cancer if dust from product is inhaled. Causes damage to lungs and respiratory system through prolonged or repeated inhalation of dust from product.

Intact fibre cement products are not expected to result in any adverse toxic effects. The hazard associated with fibre cement arises from the respirable crystalline silica present in dust generated by activities such as cutting, rebating, drilling, routing, sawing, crushing, or otherwise abrading fibre cement, and when cleaning up, disposing of or moving dust.

When doing any of these activities in a manner that generates dust, follow James Hardie instructions and best practices to reduce or limit the release of dust.

If using a dust mask or respirator, use an AS/NZS 1716 P1 filter and refer to Australian/New Zealand Standard 1715:2009 Selection, Use and Maintenance of Respiratory Protective Equipment for more extensive guidance and more options for selecting respirators for workplaces. For further information, refer to our installation instructions and Safety Data Sheets available at www.jameshardie.co.nz.

FAILURE TO ADHERE TO OUR WARNINGS, SAFETY DATA SHEETS, AND INSTALLATION INSTRUCTIONS MAY LEAD TO SERIOUS PERSONAL INJURY OR DEATH.

Crystalline Silica is

- Commonly known as sand or quartz
- Found in many building products e.g. concrete, bricks, grout, wallboard, ceramic tiles, and all fibre cement materials

Why is Crystalline Silica a health hazard?

- Silica can be breathed deep into the lungs when present in the air as a very fine (respirable) dust
- Exposure to silica dust without taking the appropriate safety measures to minimise the amount being breathed in, can lead to a potentially fatal lung disease – silicosis – and has also been linked with other diseases including cancer. Some studies suggest that smoking may increase these risks
- The most hazardous dust is the dust you cannot see!

When is Crystalline Silica a health hazard?

- It's dangerous to health if safety protocols to control dust are not followed when cutting, drilling or rebating a product containing crystalline silica and when cleaning up
- Products containing silica are harmless if intact (e.g. an un-cut sheet of wall board)

Avoid breathing in crystalline silica dust

Safe working practices

- ✗ NEVER use a power saw indoors or in a poorly ventilated area
- ✗ NEVER dry sweep
- ✓ ALWAYS use M Class or higher vacuum or damp down dust before sweeping up
- ✗ NEVER use grinders
- ✓ ALWAYS use a dust reducing circular saw equipped with a sawblade specifically designed to minimise dust creation when cutting fibre cement – preferably a sawblade that carries the Hardie™ Blade name or one with at least equivalent performance – connected to an M Class or higher vacuum
- ✓ Before cutting warn others in the area to avoid dust
- ✓ ALWAYS follow tool manufacturers' safety recommendations
- ✓ ALWAYS expose only the minimum required depth of blade for the thickness of fibre cement to be cut
- ✓ ALWAYS wear a properly-fitted, approved dust mask or respirator P1 or higher in accordance with applicable government regulations and manufacturer instructions
- ✓ Consider rotating personnel across cutting tasks to further limit respirable silica exposures.

When cutting Oblique™ Weatherboard:

- ✓ Work outdoors only
- ✓ Make sure you work in a well ventilated area
- ✓ Position cutting station so wind will blow dust away from yourself and others in the working area
- ✓ Rotate employees across cutting task over duration of shift
- ✓ Cut products with a Hardie™ Blade Saw Blade (or equivalent) and a dust reducing circular saw connected to a M Class or higher vacuum
- ✓ When sawing, sanding, rebating, drilling or machining fibre cement products, always:
 - Wear your P1 or higher (correctly fitted in accordance with manufacturers' instructions), ask others to do the same.
 - Keep persons on site at least 2 metres and as far as practicable away from the cutting station while the saw is in operation
 - If you are not clean shaven, then use a powered air respirator with a loose fitting head top
 - Wear safety glasses
 - Wear hearing protection
- ✓ Make sure you clean up BUT never dry sweep. Always hose down with water/wet wipe or use an M Class or higher vacuum

If concern still exists about exposure levels or you do not comply with the above practices, you should always consult a qualified industrial hygienist or contact James Hardie for further information.

Working Instructions

Hardie™ Blade Saw Blade

The Hardie™ Blade Saw Blade used with a dust-reducing saw is ideal for fast, clean cutting of Hardie™ fibre cement products. A dust-reducing saw uses a dust collector connected to a M Class or higher vacuum. When sawing, clamp a straight edge to the sheet as a guide and run the saw base plate along the straight edge when making the cut.

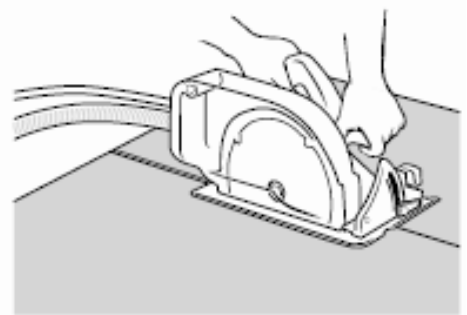

Hole-Forming

For smooth clean cut circular holes:

- Mark the centre of the hole on the sheet
- Pre-drill a 'pilot' hole
- Using the pilot hole as a guide, cut the hole to the appropriate diameter with a hole saw fitted to a heavy duty electric drill



For irregular holes:

- Small rectangular or circular holes can be cut by drilling a series of small holes around the perimeter of the hole then tapping out the waste piece from the sheet face
- Tap carefully to avoid damage to sheets, ensuring that the sheet edges are properly supported

5.1 Storage and delivery

Keeping products and people safe

Off loading

- ✓ Hardie™ fibre cement products should be off-loaded carefully by hand or by forklift
- ✓ Hardie™ fibre cement products should not be rolled or dumped off a truck during the delivery to the jobsite

Storage

Hardie™ fibre cement products should be stored:

- ✓ In their original packaging
- ✓ Under cover where possible or otherwise protected with a waterproof covering to keep products dry
- ✓ Off the ground – either on a pallet or adequately supported on timber or other spacers
- ✓ Flat so as to minimise bending

Hardie™ fibre cement products must not be stored:

- ✗ Directly on the ground
- ✗ In the open air exposed to the elements

James Hardie is not responsible for damage due to improper storage and handling.

5.2 Tips for safe and easy handling of Oblique™ Weatherboard

- ✗ Do not lift planked products flat and in the middle
- ✓ Carry the products on the edge
- ✓ If only one person is carrying the product, hold it in the middle and spread arms apart to better support the product
- ✓ If two people are carrying the plank, hold it near each end and on edge
- ✓ Exercise care when handling weatherboard products to avoid damaging the edges/corners

6 Preparation

6.1 RAB™ Board

A rigid air barrier such as HomeRAB™ Pre-Cladding or RAB™ Board by James Hardie must be used over the timber frame for the installation of Oblique™ Weatherboard as per this technical specification.

To achieve temporary weathertightness using HomeRAB™ Pre-Cladding and RAB™ Board, windows and doors must be installed and all joints taped. Refer to the HomeRAB™ Pre-Cladding and RAB™ Board installation manual for its installation information.

6.2 Cavity Closure/Vent Strip

A 40mm deep cavity closure must be provided at the bottom of cavity and above all door and window openings. It is important that the openings in the cavity closure/vent strip are kept clear and unobstructed to allow free drainage and ventilation of cavities. The cavity closure/vent strip must allow an opening area of 1000mm²/m length.

6.3 Hardie™ 40mm Structural Horizontal Cavity Batten

Hardie™ 40mm structural horizontal cavity battens are 40mm deep x 45mm high x 2.7m long with castellation to allow for ventilation/drainage and facilitate the installation of Oblique™ Weatherboard into it. The Hardie™ 40mm structural horizontal cavity battens are H3.1 treated to comply with the durability requirements of B2/AS1.

The Hardie™ 40mm structural horizontal cavity battens are to be fixed horizontally to the frame/substrate. Refer to Table 4 below regarding the batten spacing and its fixing to timber studs.

Table 4

Framing	Wind Zone	Studs spacing centres max.	Hardie™ 40mm structural horizontal cavity batten spacing centres max.	Fixing into Stud
Timber	Up to and including VH	400mm	400mm	1 x 75 x 3.06mm RounDrive ring shank nail galv/ss or 80 x10g wood thread stainless steel screw
		400mm	600mm	2 x 75 x 3.06mm RounDrive ring shank nail galv/ss or
		600mm	400mm	80x10g wood thread stainless steel screw
	EH	400mm	450mm	2 x 75 x 3.06mm RounDrive ring shank nail galv/ss or 80x10g wood thread stainless steel screw

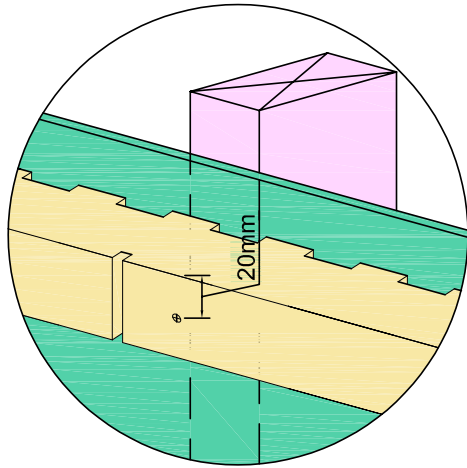

Screw fixing for timber stud.
Refer to table 4

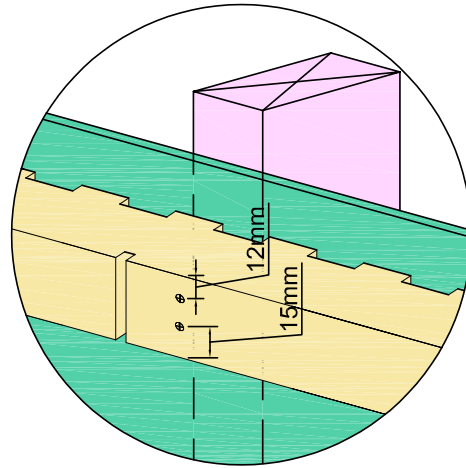

Nail fixing for timber stud.
Refer to table 4

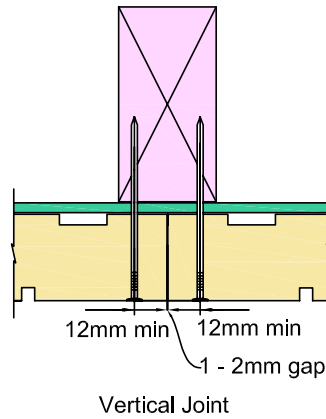

6.4 Flashings

All wall openings, penetrations, intersections, connections, window sills, heads and jambs must be flashed prior to Oblique™ Weatherboard installation. The rigid air barrier must be appropriately incorporated with penetration and junction flashings using flashing tapes. Ensure to check the compatibility of flashing tapes and sealants with their manufacturers. Refer to the HomeRAB™ Pre-Cladding and RAB™ Board installation manual for further information.

7 Installation

7.1 General

Oblique™ Weatherboard is installed vertically using the cavity construction method as per the details and information published in this supplement.

Oblique™ Weatherboard must be kept under cover whilst in storage or at sites and they must be dry at the time of their installation. All site-cut board edges must be sealed with Dulux® 1 Step, Resene® Quick Dry, Taubmans® Underproof Acrylic Primer Undercoat or a similar sealer compatible with the finish coat before installation.

Oblique™ Weatherboards must be fixed into Hardie™ 40mm structural horizontal cavity battens. Ensure that the weatherboards are hard against the battens to avoid drumminess before fixing.

7.2 Fastener

Oblique™ Weatherboard must be fixed vertically to Hardie™ 40mm structural horizontal cavity battens using fixings as specified in Table 5 below.

Table 5

Fixing Type	Fixing Spacing	Reference
50 x 2.87mm D head or RounDrive ring shank nails	Fix nail into structural cavity batten each batten crossing.	Refer to Figure 5

When fixing the Oblique™ Weatherboard using nail guns, refer to the nail gun manufacturer for information about nails and the type of nail gun to be used

- D head nails - finish nails 2mm below weatherboard surface
- RounDrive nails - finish nails flush with weatherboard surface

7.3 Fastener Durability

Fasteners must meet the minimum durability requirements of the NZBC. Refer to Table 6 for fixing materials requirements to be used in relation to the exposure conditions.

Table 6

Exposure conditions and nail selection prescribed by NZS 3604		
Zone	Application	
D (sea spray) and geothermal hot spots	General	Stainless steel 304/316
	Fire	
*C and B	General	Hot dip galvanised**
	Fire	

* Zone C areas where local knowledge dictates that increased durability is required, appropriate selection shall be made Microclimatic conditions as detailed in NZS 3604, Paragraph 4.2.4 require SED.

**Hot dip galvanised must comply with AS/NZS 4680.

Also refer to the NZBC Acceptable Solution E2/AS1 Table 20 and 21 for information regarding the selection of suitable fixing materials and their compatibility with other materials.

7.4 Vertical Joint

Oblique™ Weatherboard vertical joint shall be formed using the ship lap edge of the Oblique™ Weatherboard. Ensure that the Oblique™ Weatherboards are securely interlocked before nailing, refer to Figures 5.

7.5 Horizontal Joint

Oblique™ Weatherboard can run continuously over floor joists without a flashed horizontal joint when LVL timber floor joists or engineered joists are used. Refer to Figure 22.

When using a solid timber joist, a horizontal joint or a movement joint can be formed at floor joist, refer to Figure 23.

7.6 Drainage Joint

After every two floors, a horizontal drainage joint flashing is required as per E2/AS1. Refer to Figure 25.

7.7 External Corner

An external box corner flashing is used to form the external corners, refer to Figures 6 and 8. Alternatively, a Hardie™ Axent™ Trim external boxed corner can also be formed, refer to Figure 7.

7.8 Internal Corner

An internal corner flashing is to be used to form an internal corner joint, refer to Figure 9. An extra stud is required in internal corners.

Note: All joint mouldings to be fixed at 400mm centres both sides.

8 Finishes

8.1 Preparation

The D head nail must be finished 2mm below the cladding surface. The nail holes must be filled with an exterior grade two part builders fill, ie. CRC® ADOS® Builders Fill or similar two part external grade filler. The RoundDrive nail heads must finish flush with cladding surface.

8.2 Painting

Oblique™ Weatherboard is pre-primed and is suitable for site applied acrylic paints.

In order to seal cut edges or sanded patches, Dulux® 1 Step, Resene® Quick Dry, Taubmans® Underproof Acrylic Primer Undercoat or a similar product should be applied. The primer should be compatible with the paint to be used.

Painting of Oblique™ Weatherboard is mandatory to meet the durability requirements of the NZBC and 25 year James Hardie product warranty. Oblique™ Weatherboard must be dry and free of any dust or grime before painting. The cladding must be painted within 90 days of installation. There is no restriction on the LRV of paint to be applied on the Oblique™ Weatherboard.

James Hardie recommends a minimum of two coats of exterior grade acrylic paint. Follow the paint manufacturer's recommendations to prepare the surface and to adequately cover and conceal the cladding fixings.

For the best aesthetic results a low sheen paint is recommended.

8.3 Flexible Sealant

Sealant used must comply with the relevant requirements of the NZBC. Their application and usage must be in accordance with the manufacturer's instructions. Check with the sealant manufacturer prior to coating over sealant. Some sealant manufacturers do not recommend coating over their product.

9 Care and Maintenance

The extent and nature of maintenance required will depend on the geographical location and exposure of the building. It is the responsibility of the specifier to determine normal maintenance requirements to maintain the effectiveness of the cladding.

As a guide, it is recommended that the basic normal maintenance tasks shall include, but not be limited to:

- Washing down your exterior every 6-12 months using low pressure water and a brush, and every 3-4 months in extreme coastal conditions (such as high winds and sea spray). Do not use a water blaster to wash down the cladding and always refer to your paint manufacturer for washing down requirements.
- Clean out your gutters, downpipes and overflow pipes as required
- Cut back vegetation and landscaping which is too close to or touching the Oblique™ Weatherboard
- Re-applying exterior protective finishes. Always refer to the paint manufacturer for recoating requirements related to ongoing paint performance
- Maintaining the exterior envelope and connections including joints, penetrations, flashings and sealants
- The clearances between the bottom edge of the Oblique™ Weatherboard and the ground must always be maintained

10 Details section index

Table 7

Description	Page
Figure 1: Framing setout	22
Figure 2: Cladding layout	23
Figure 3: Foundation detail	24
Figure 4: Enclosed deck	25
Figure 5: Fixing detail	26
Figure 6: External aluminium box corner	27
Figure 7: External corner with facings	28
Figure 8: External aluminium box corner negative detail	29
Figure 9: Internal aluminium corner	30
Figure 10: Soffit detail	31
Figure 11: Nil soffit detail	32
Figure 12: Soffit detail top ventilation	33
Figure 13: Nil soffit detail top ventilation	34
Figure 14: Window sill	35
Figure 15: Window jamb	36
Figure 16: Window head with cladding cut around head flashing	37
Figure 17: Window sill with facing	38
Figure 18: Window jamb with facing	39
Figure 19: Window head with facing	40
Figure 20: Door sill support detail	41
Figure 21: Horizontal joint over joist at floor level	42
Figure 22: Continuous cladding over joist at floor level	43
Figure 23: Trimline joint flashing	44
Figure 24: Trimline joint flashing jointing - Option A	45
Figure 25: Trimline joint flashing at external corner - Option B	46
Figure 26: Trimline joint flashing at internal corner	47
Figure 27: Drained flashing joint at floor level	48
Figure 28: Drained flashing joint at external corner	49
Figure 29: Pipe penetration	50
Figure 30: Apron flashing detail	51
Figure 31: Parapet flashing	52
Figure 32: Roof to wall junction detail	53
Figure 33: Garage door jamb	54
Figure 34: Garage door head	54

Figure 1: Framing setout

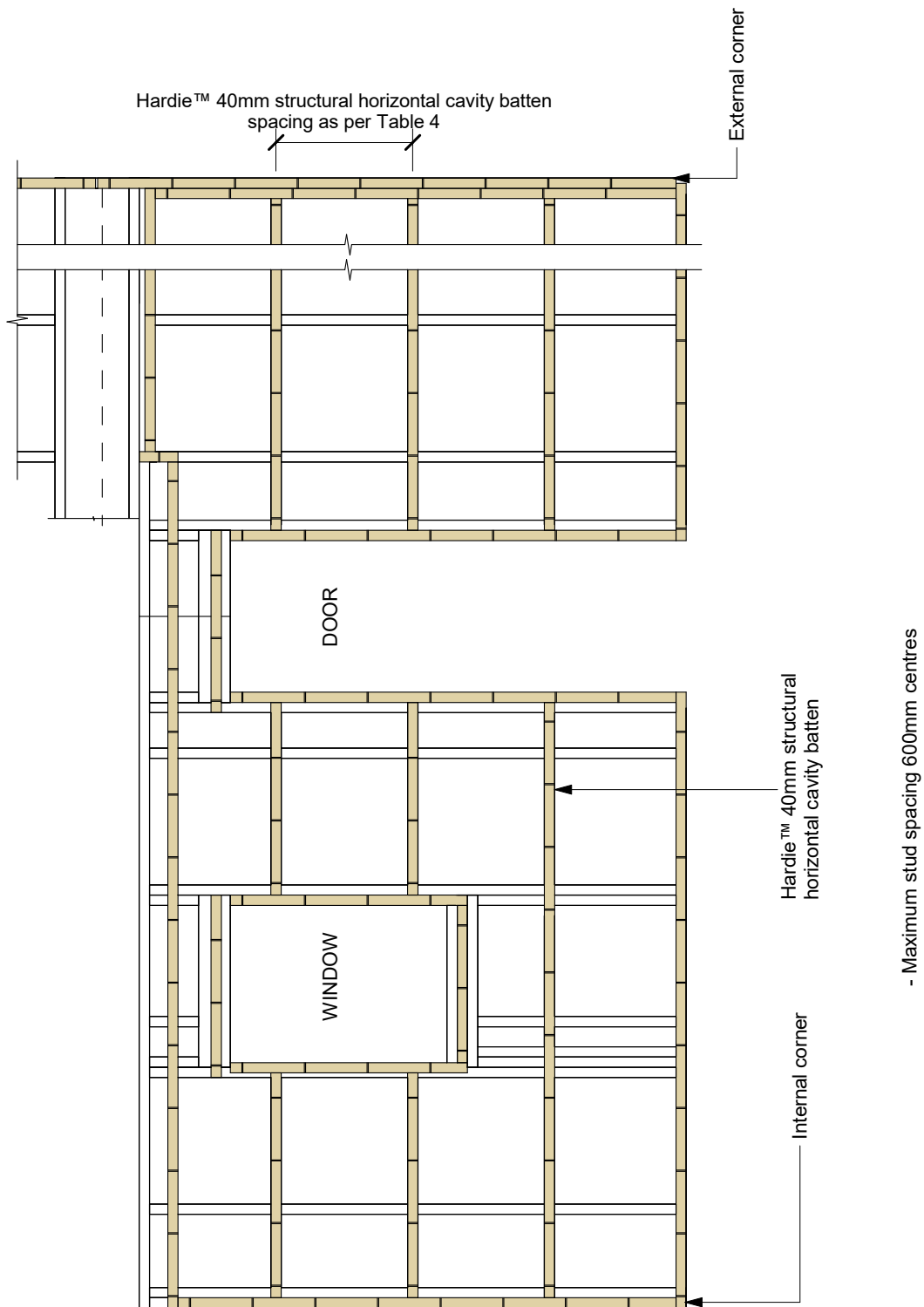

Figure 2: Cladding layout

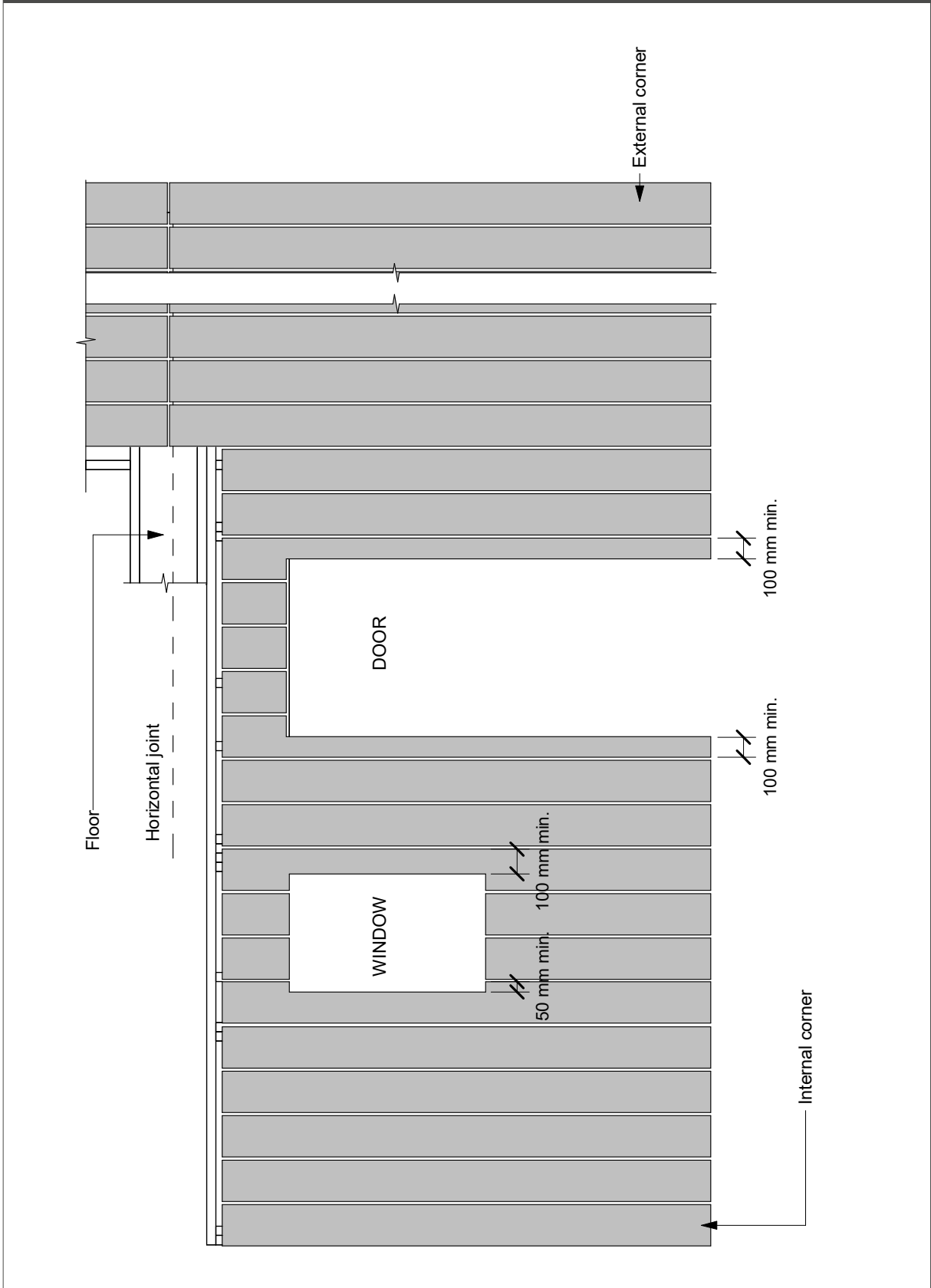
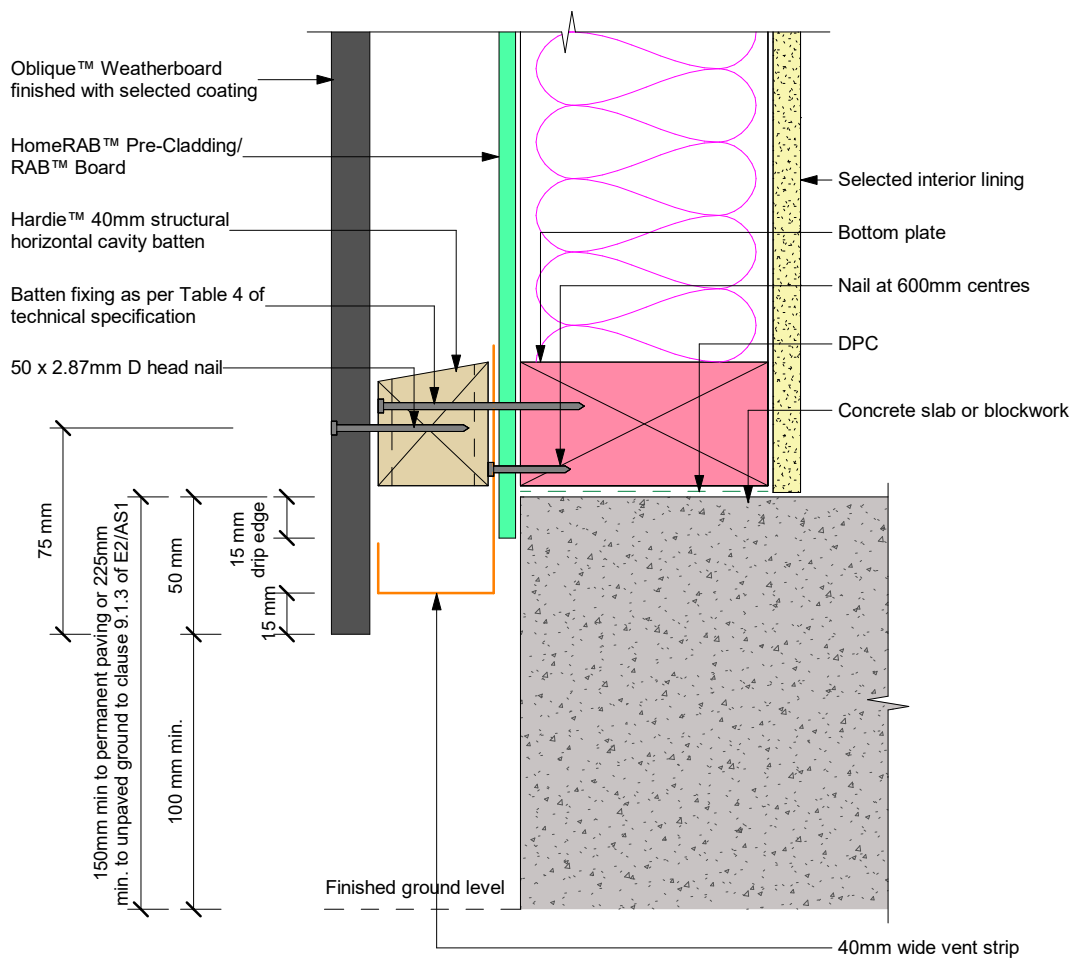

Figure 3: Foundation detail



Note: Site cut edges to be primed

Figure 4: Enclosed deck

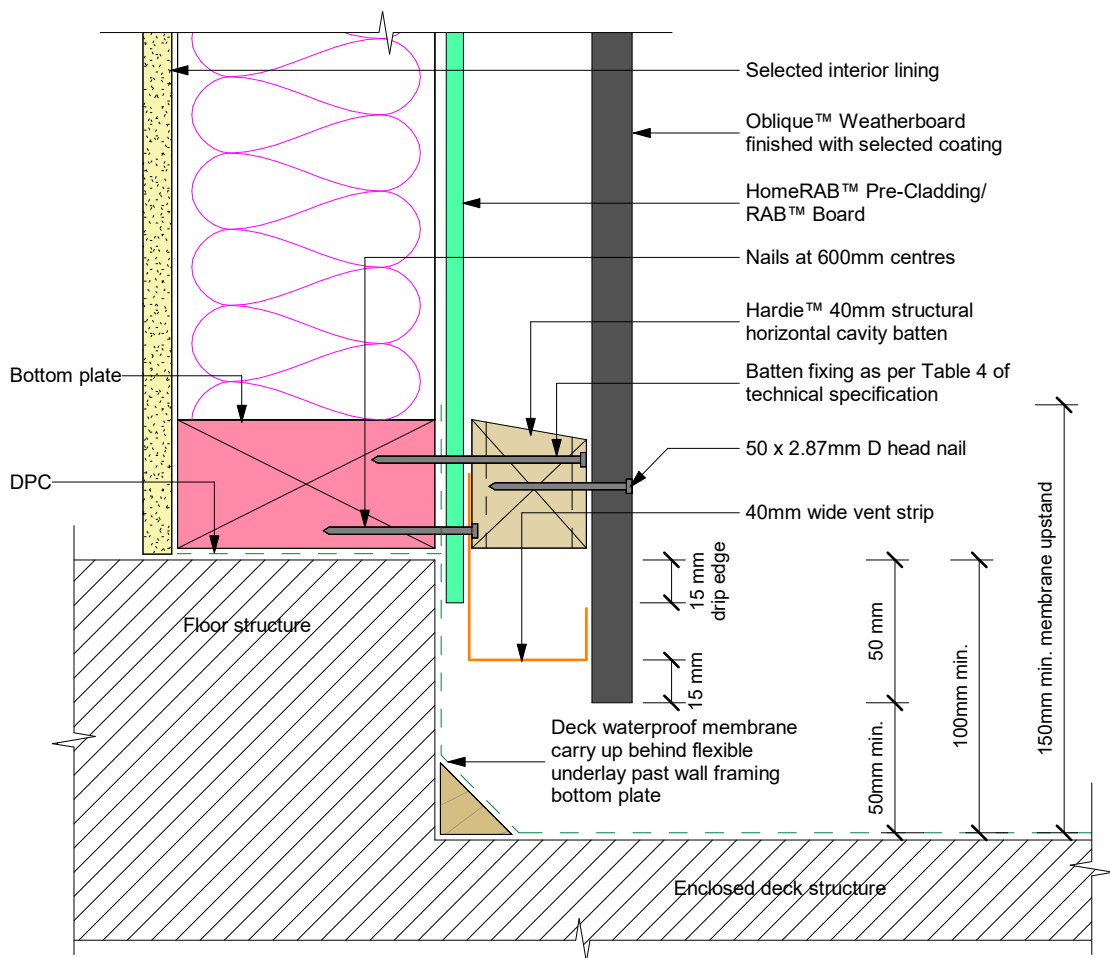

Figure 5: Fixing detail

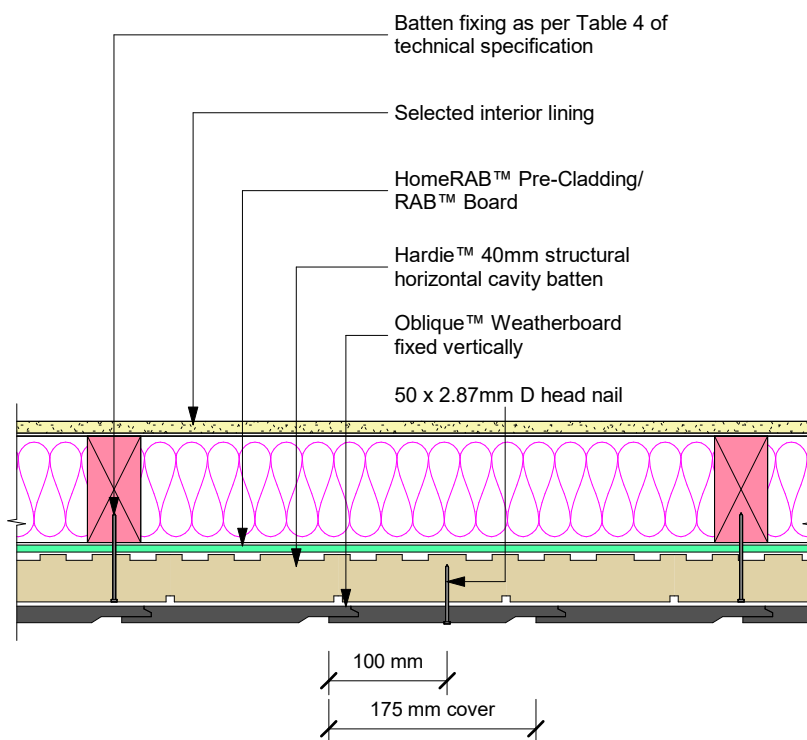
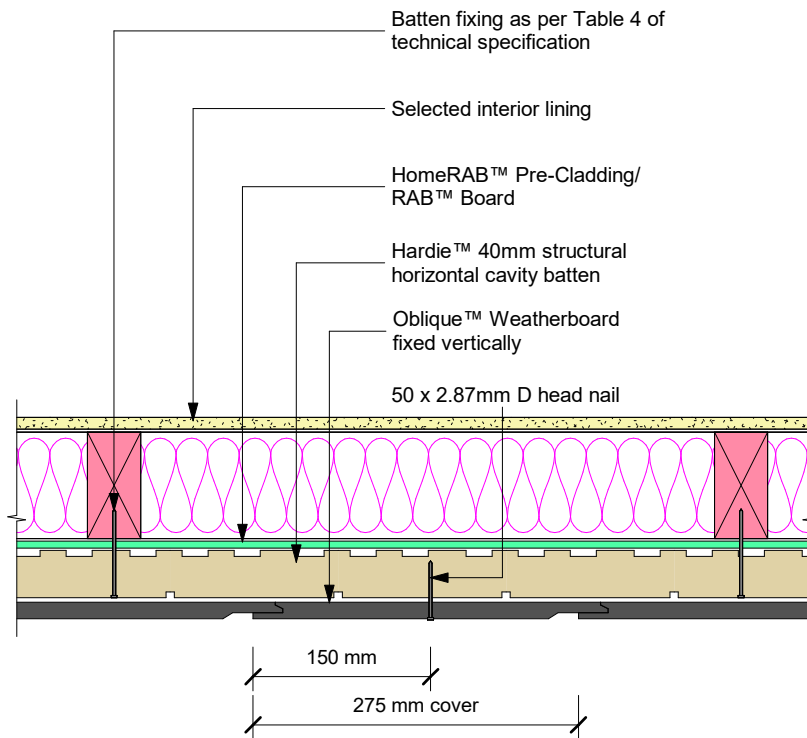

Figure 6: External aluminium box corner

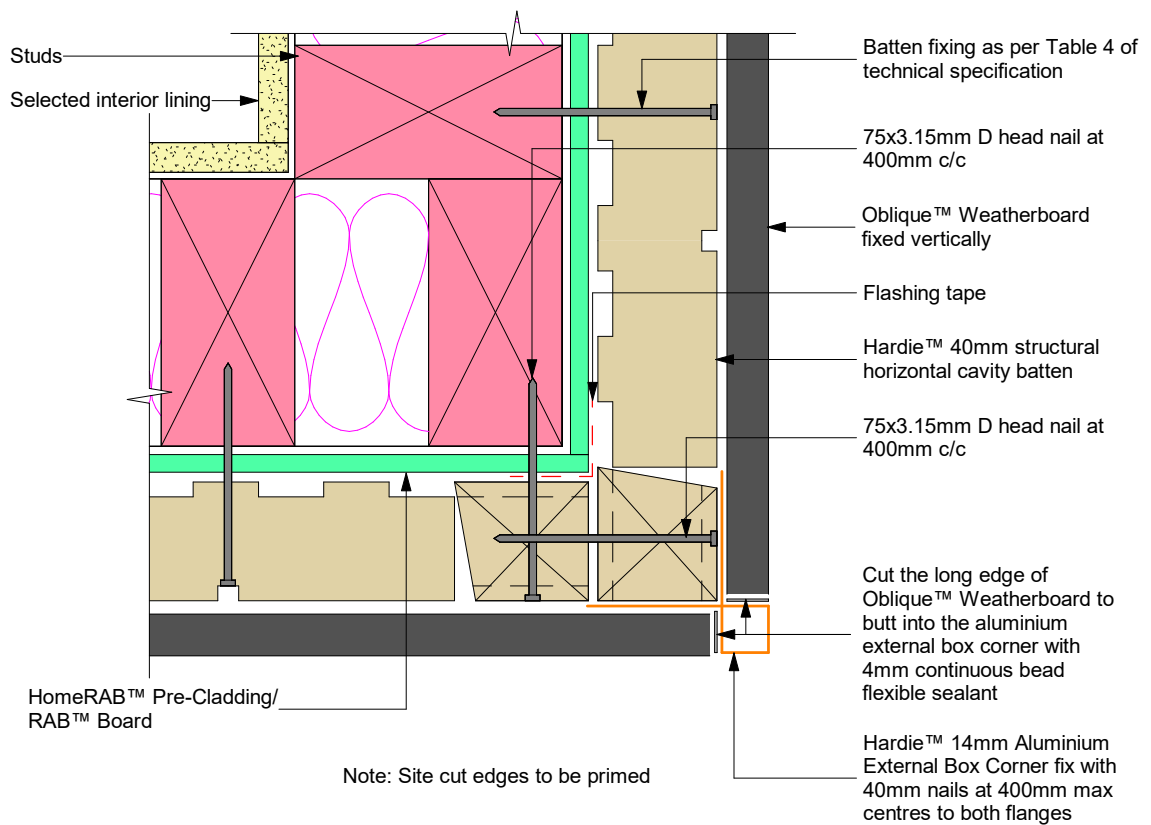
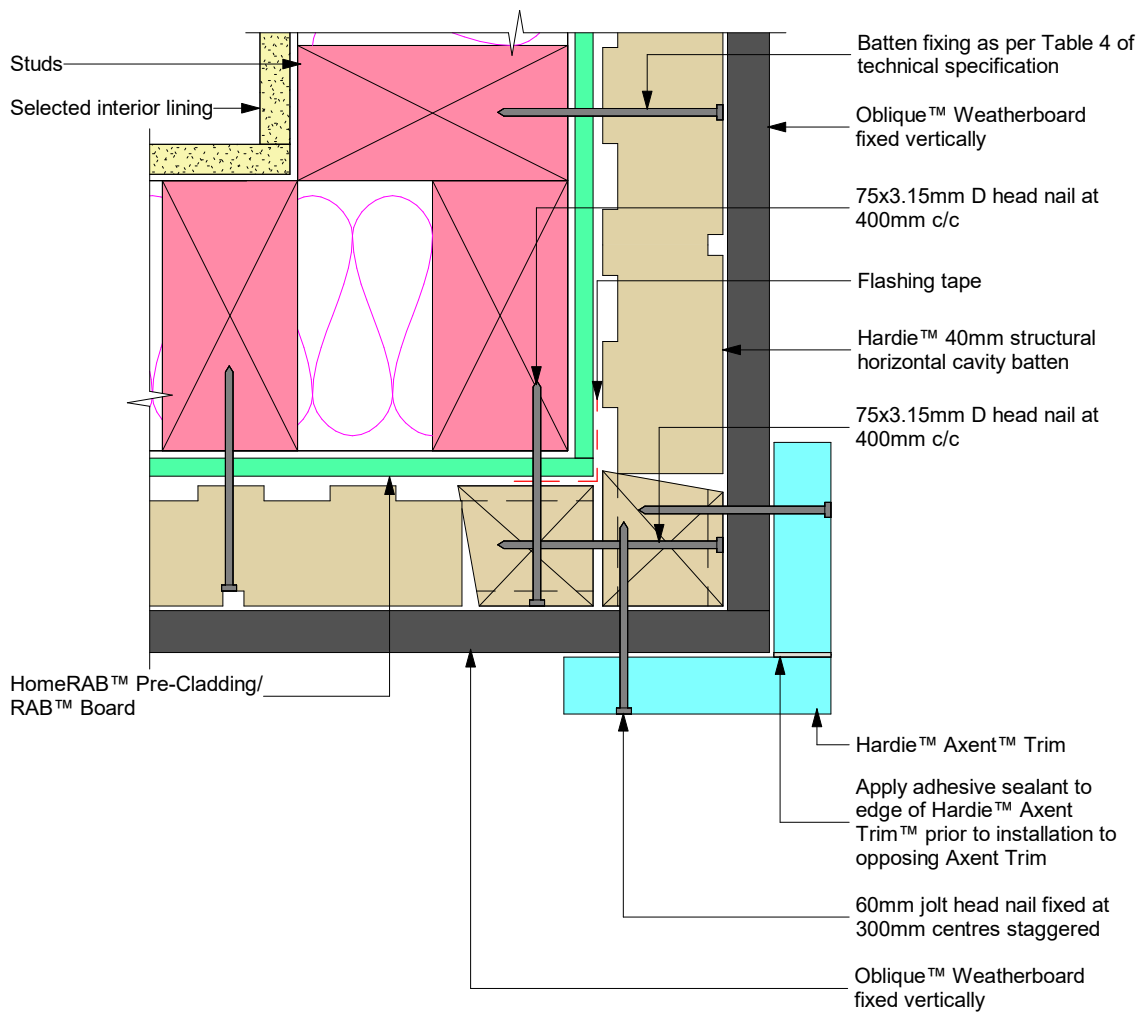

Figure 7: External corner with facings



Note: Site cut edges to be primed

Figure 8: External aluminium box corner negative detail

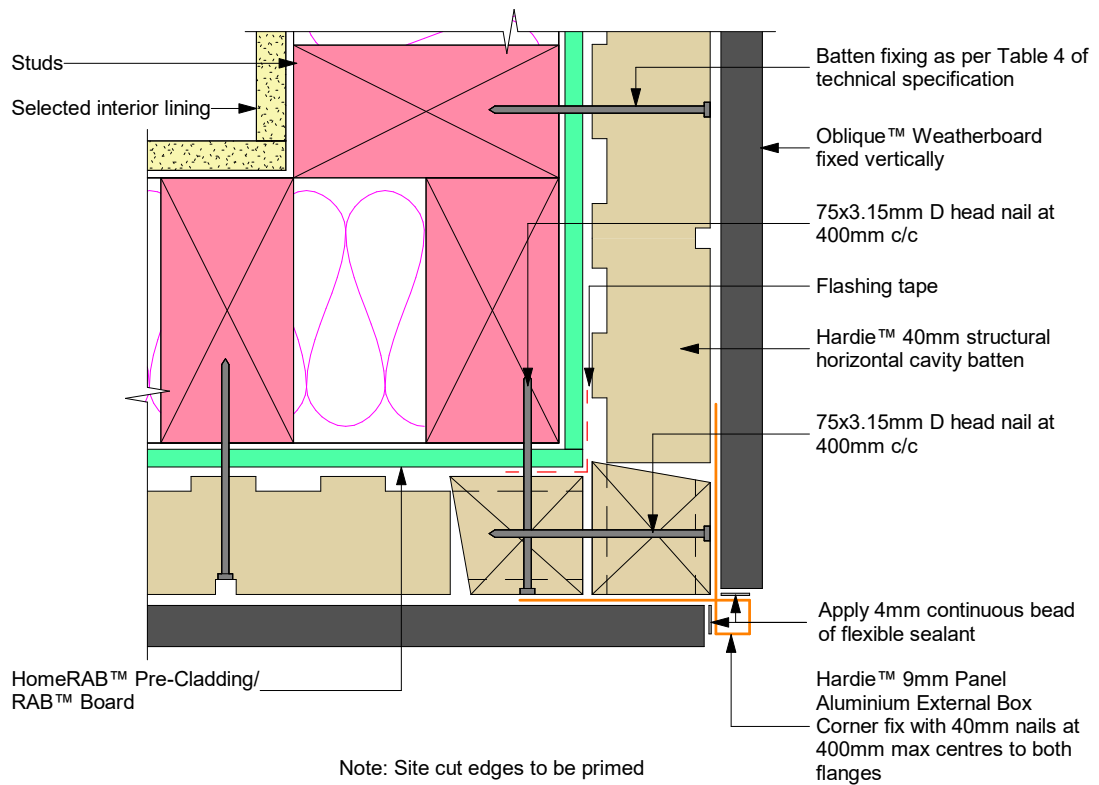
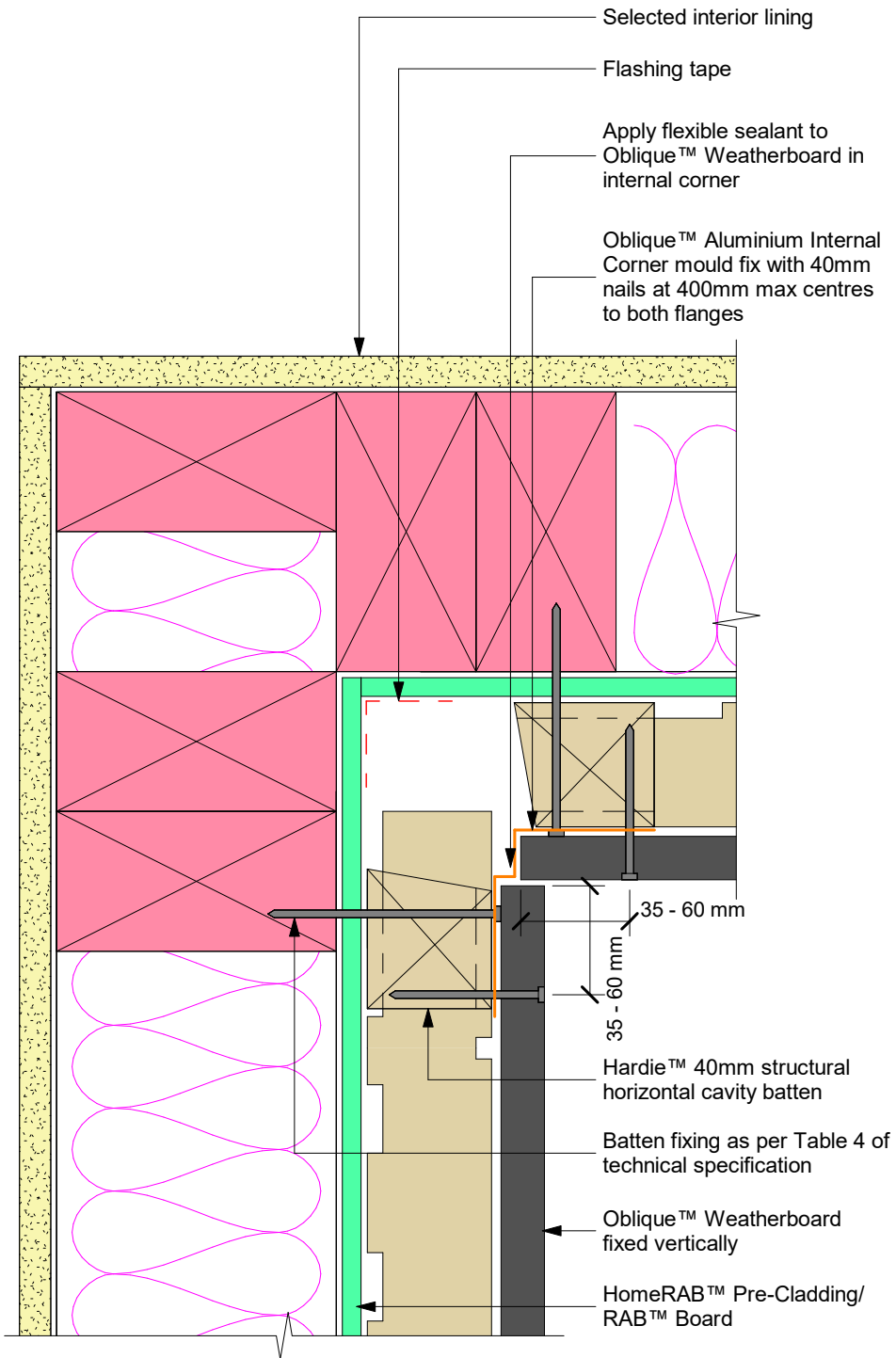
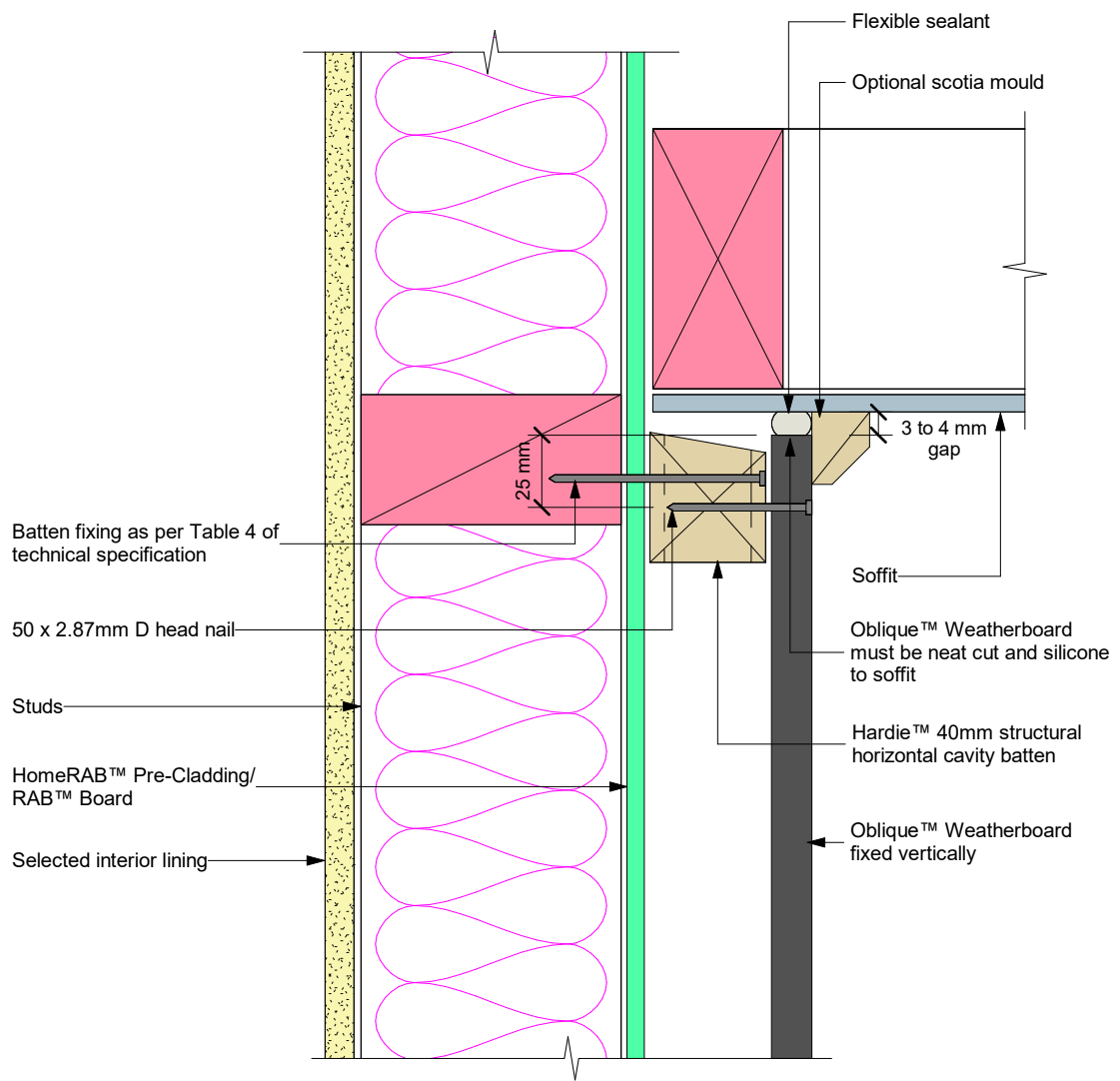

Figure 9: Internal aluminium corner



Note: Site cut edges to be primed

Figure 10: Soffit detail



Note: Site cut edges to be primed

Figure 11: Nil soffit detail

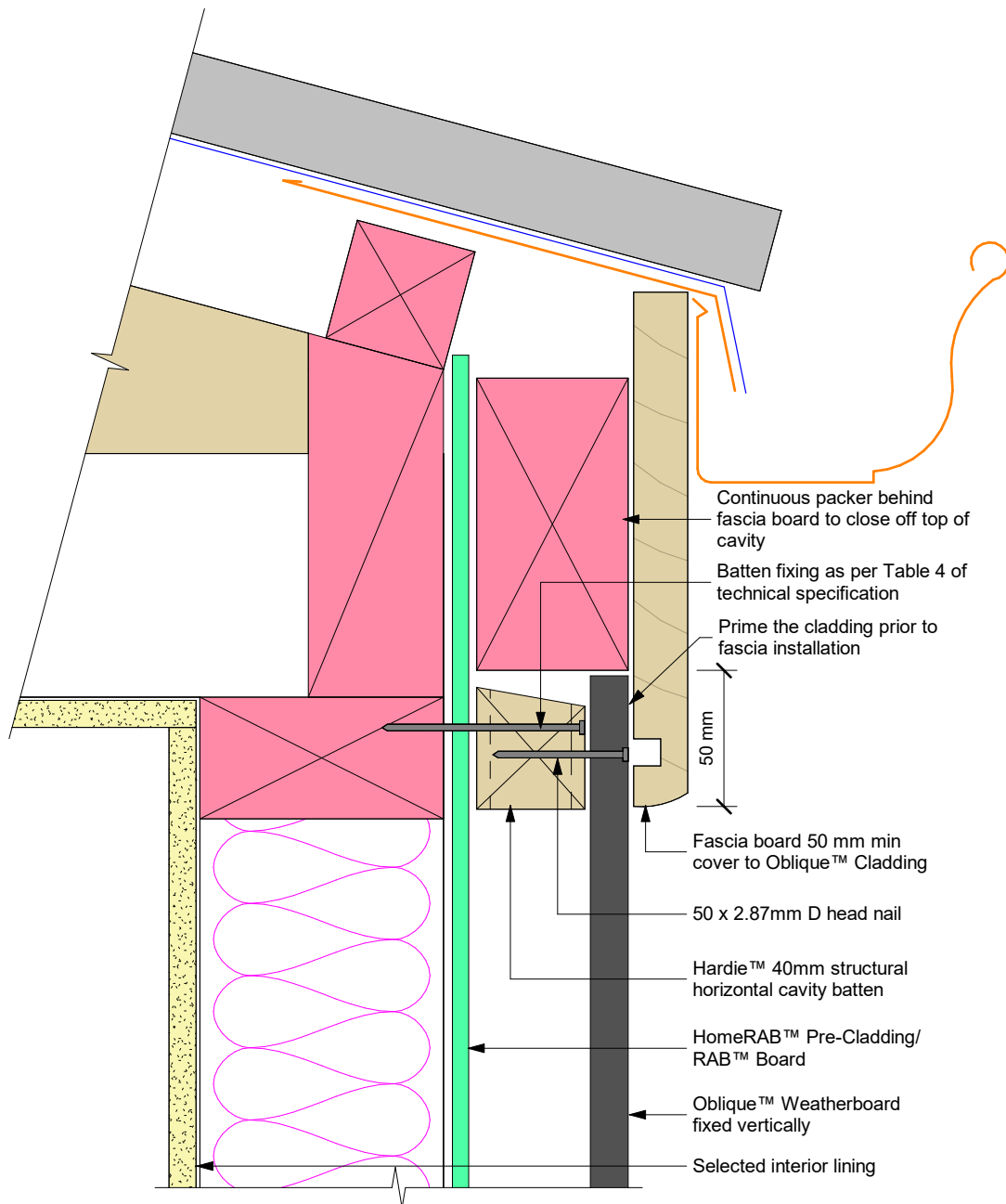

Figure 12: Soffit detail top ventilation

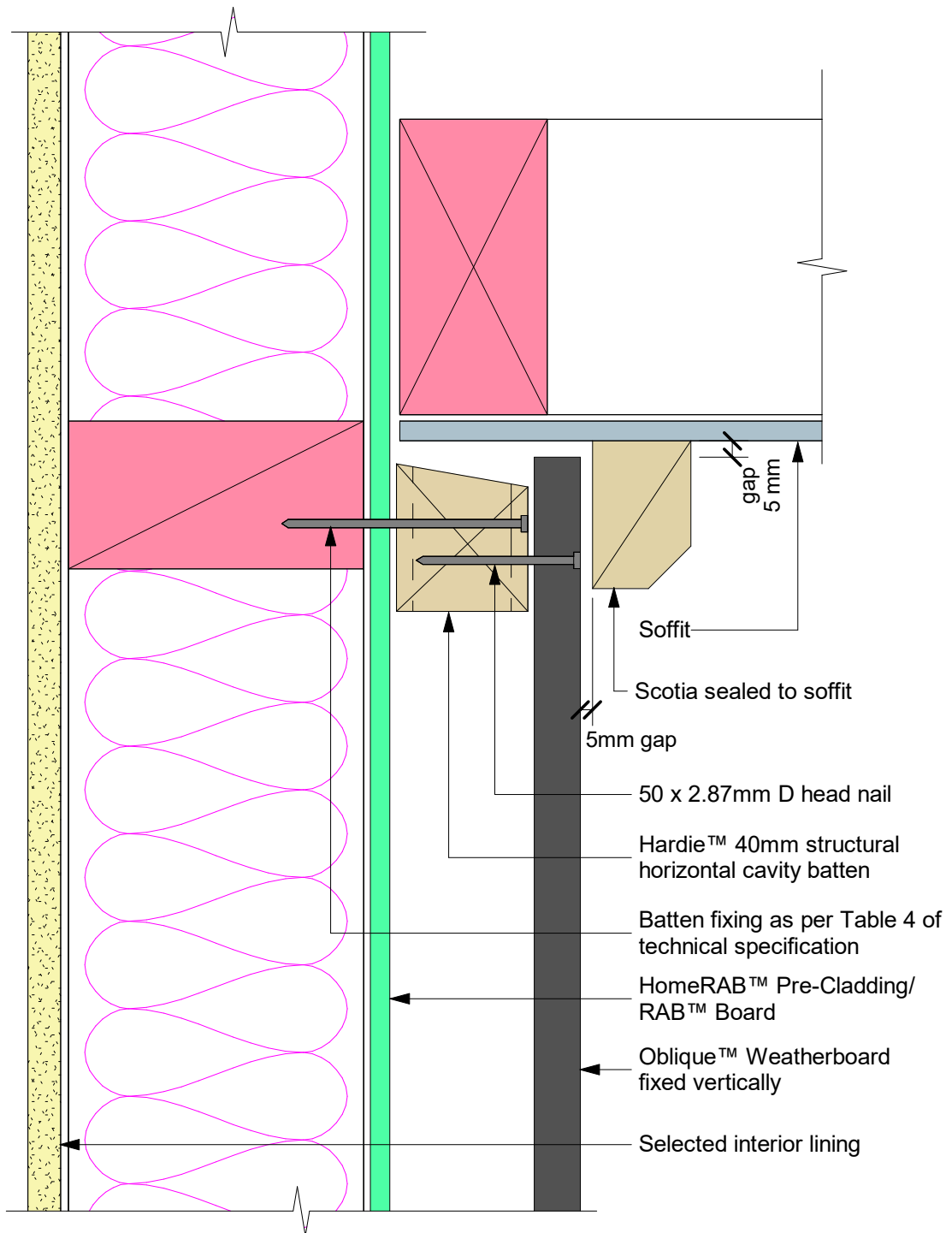

Figure 13: Nil soffit detail top ventilation

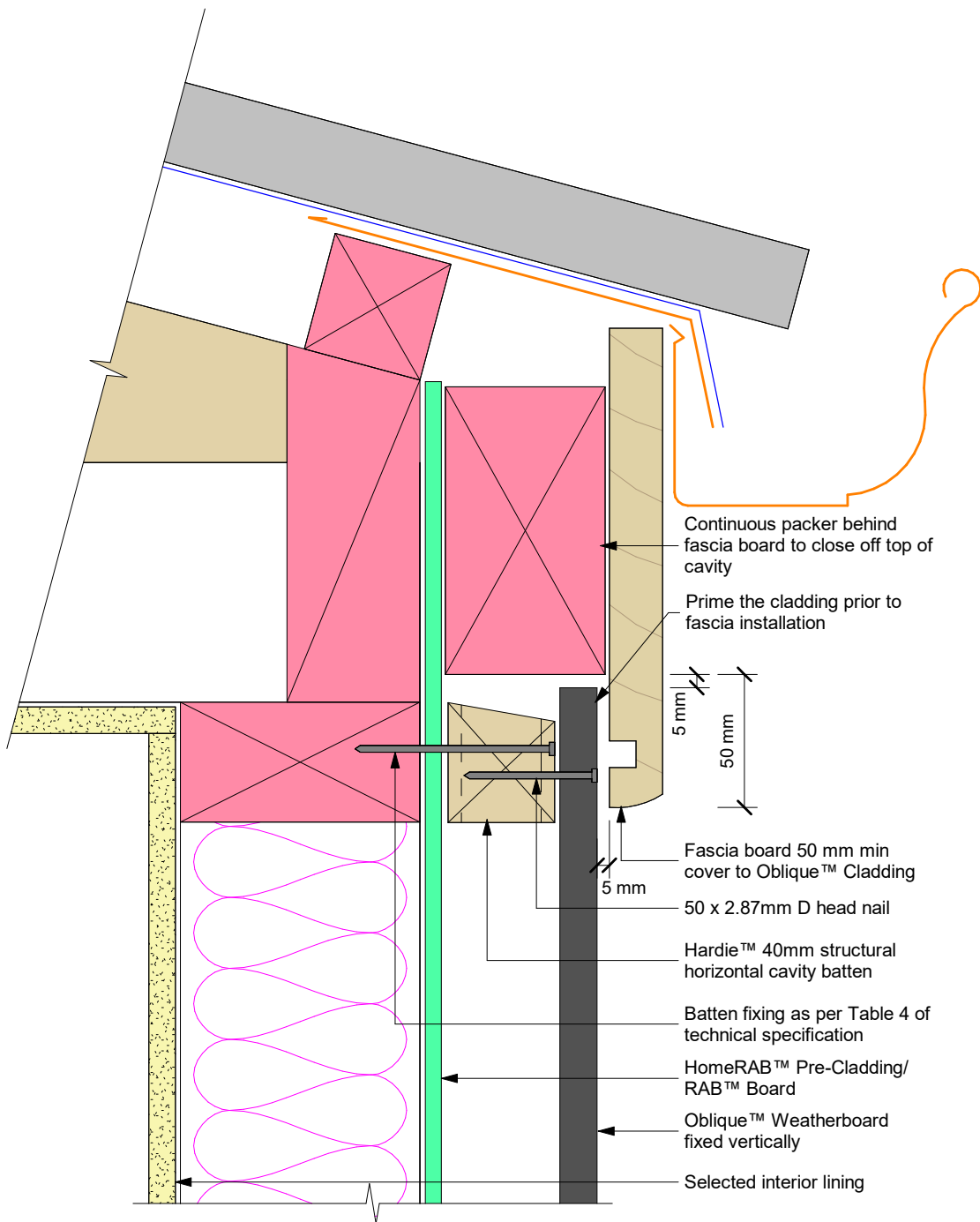
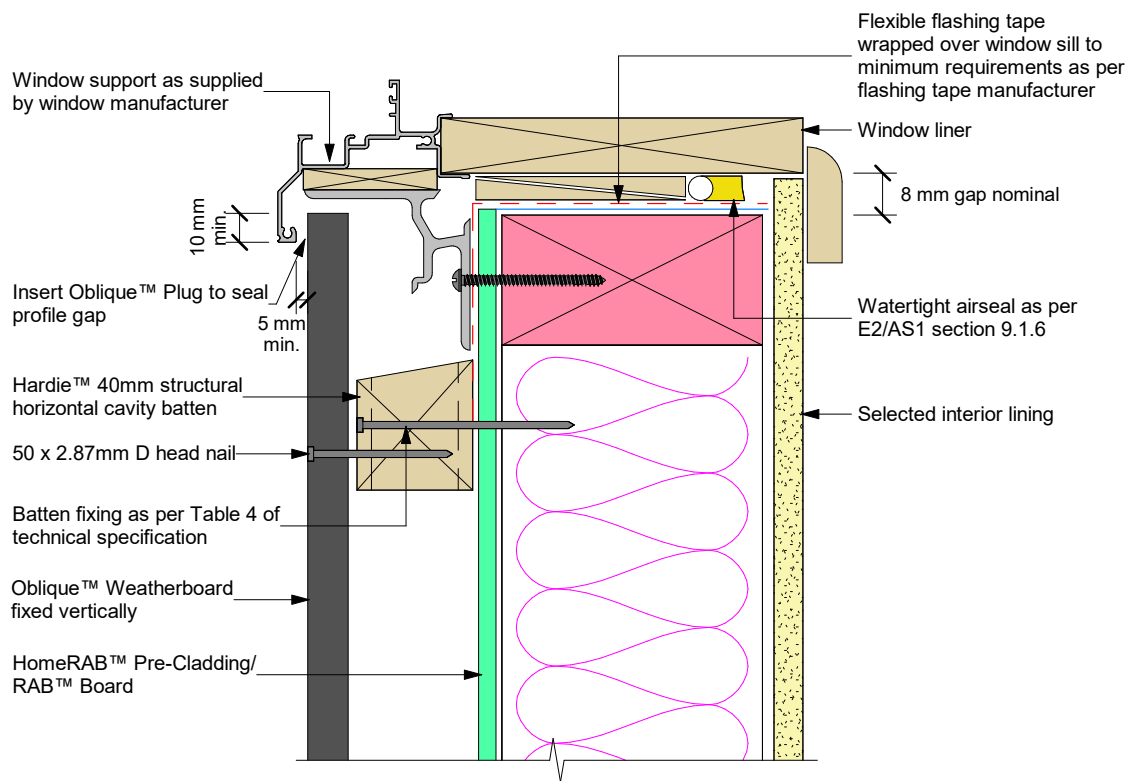

Figure 14: Window sill



Note: Site cut edges to be primed

Figure 15: Window jamb

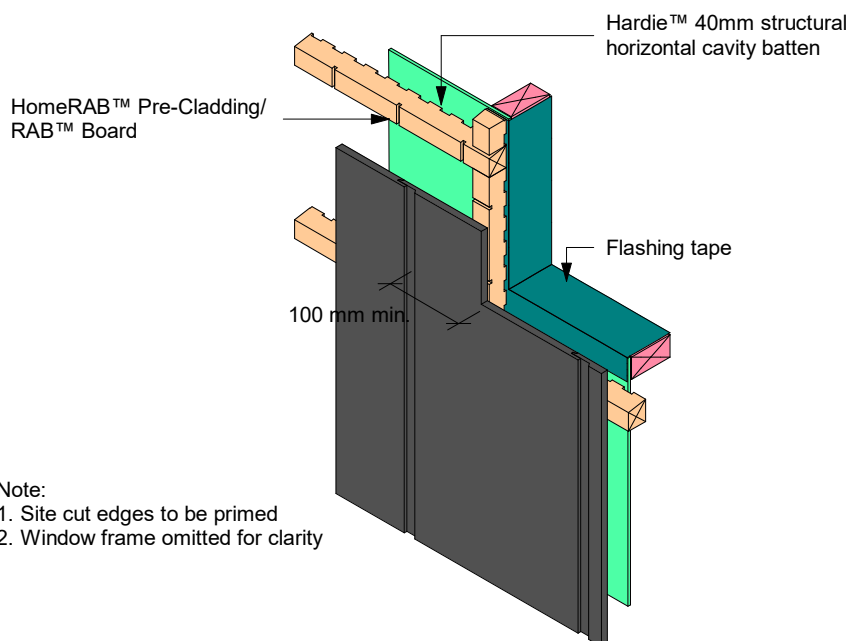
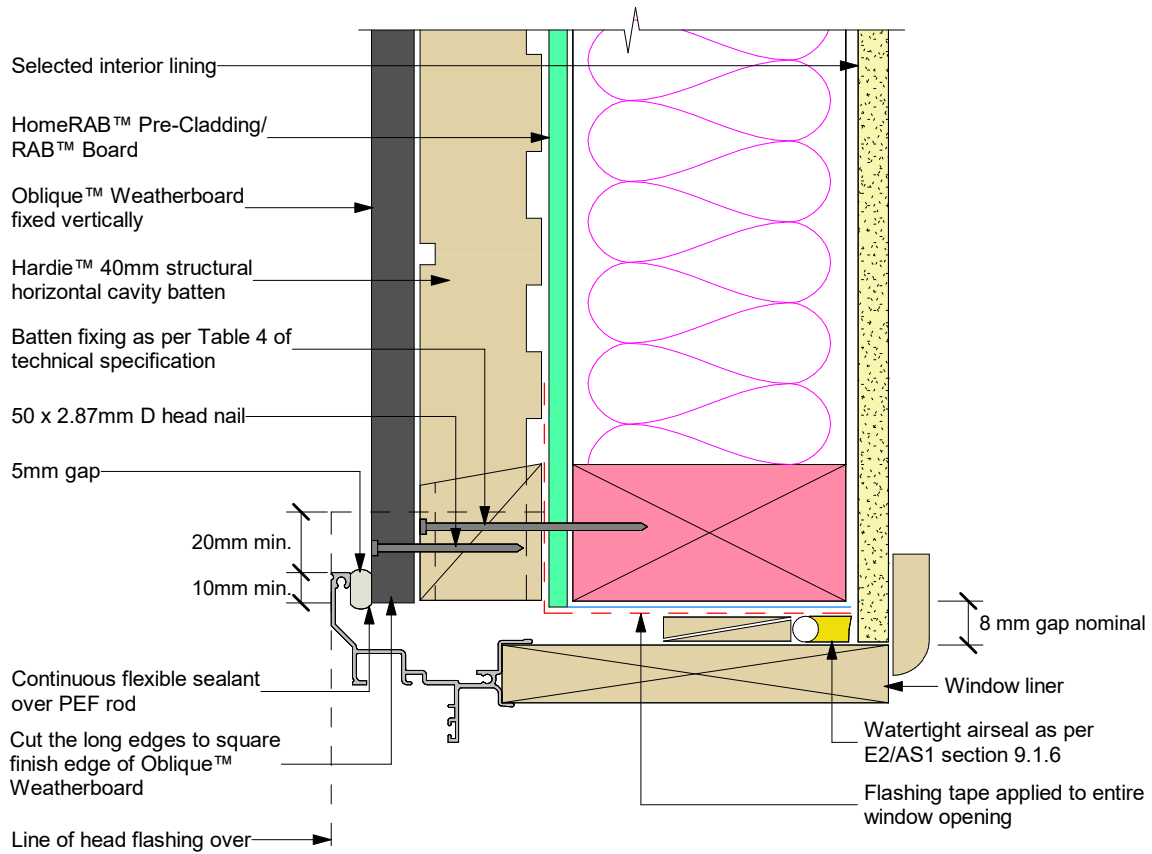
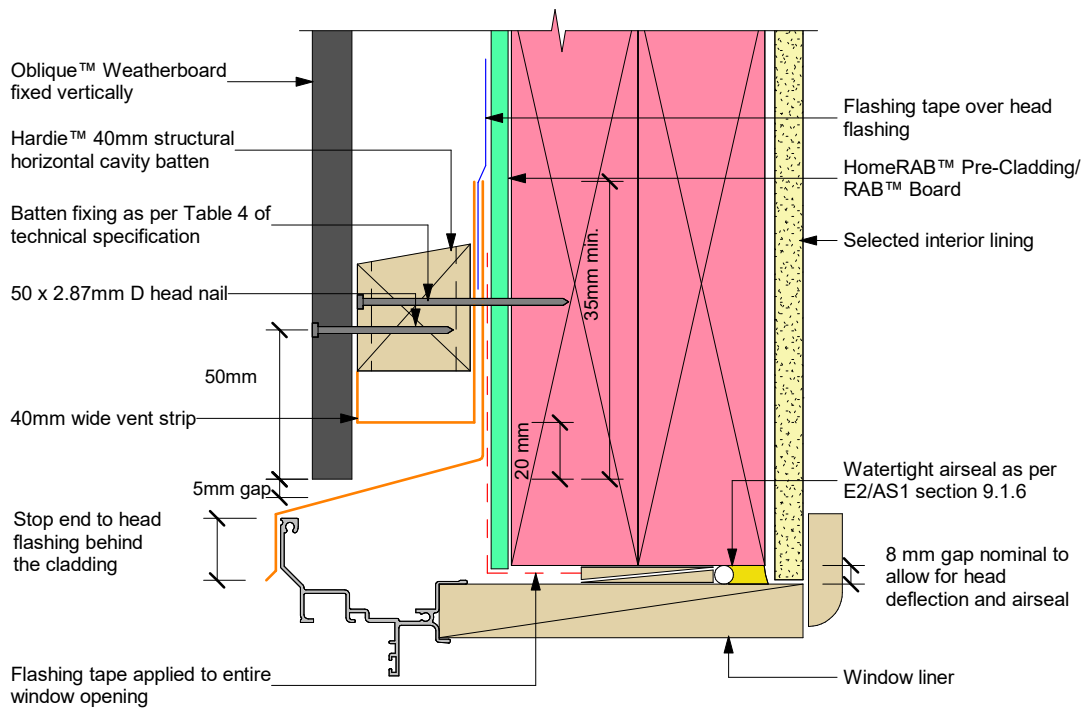

Figure 16: Window head with cladding cut around head flashing



Note:

1. Site cut edges to be primed
2. Sealant must be installed between head flashing and window flange in VH and above wind zones. Refer to Figure 71 of E2/AS1

Figure 17: Window sill with facing

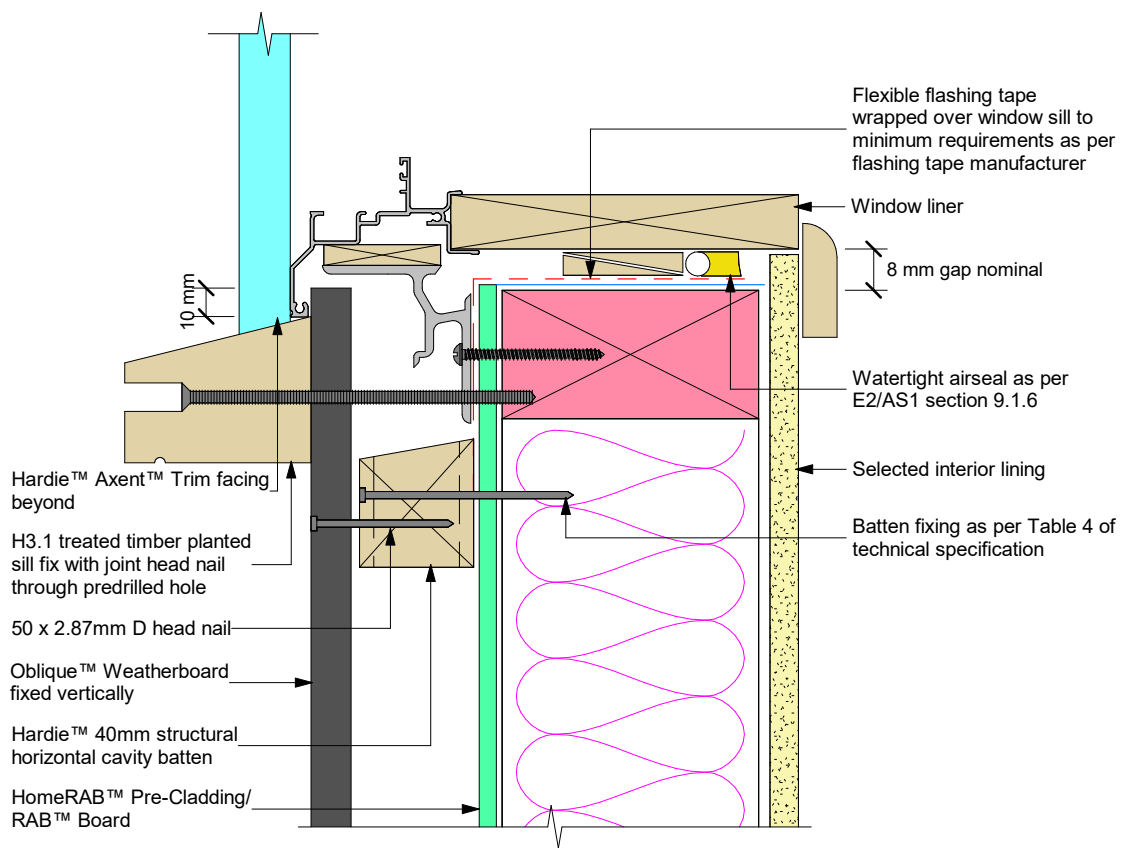

Note: Site cut edges to be primed

Figure 18: Window jamb with facing

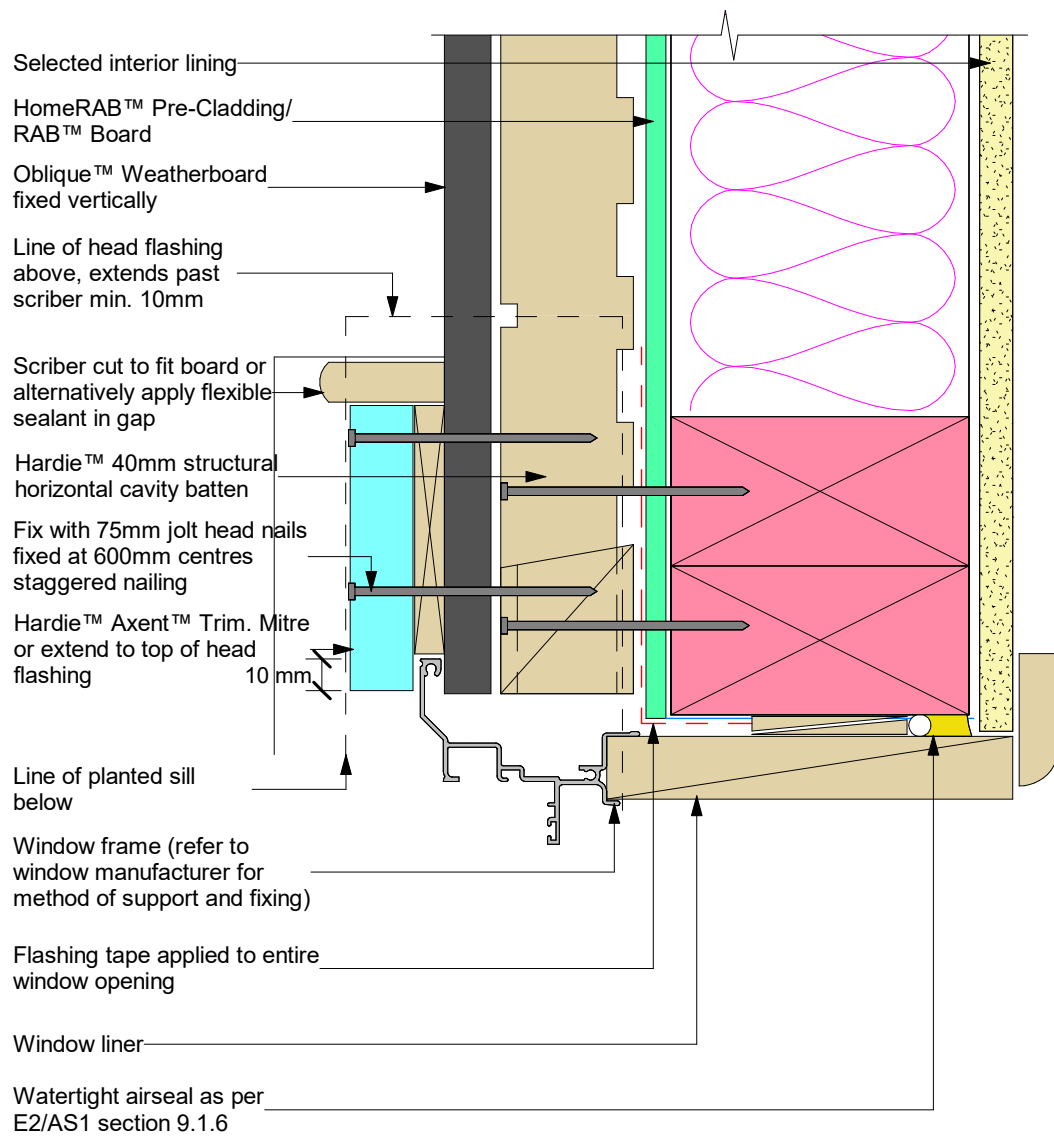

Note:
Site cut edges to be primed

Figure 19: Window head with facing

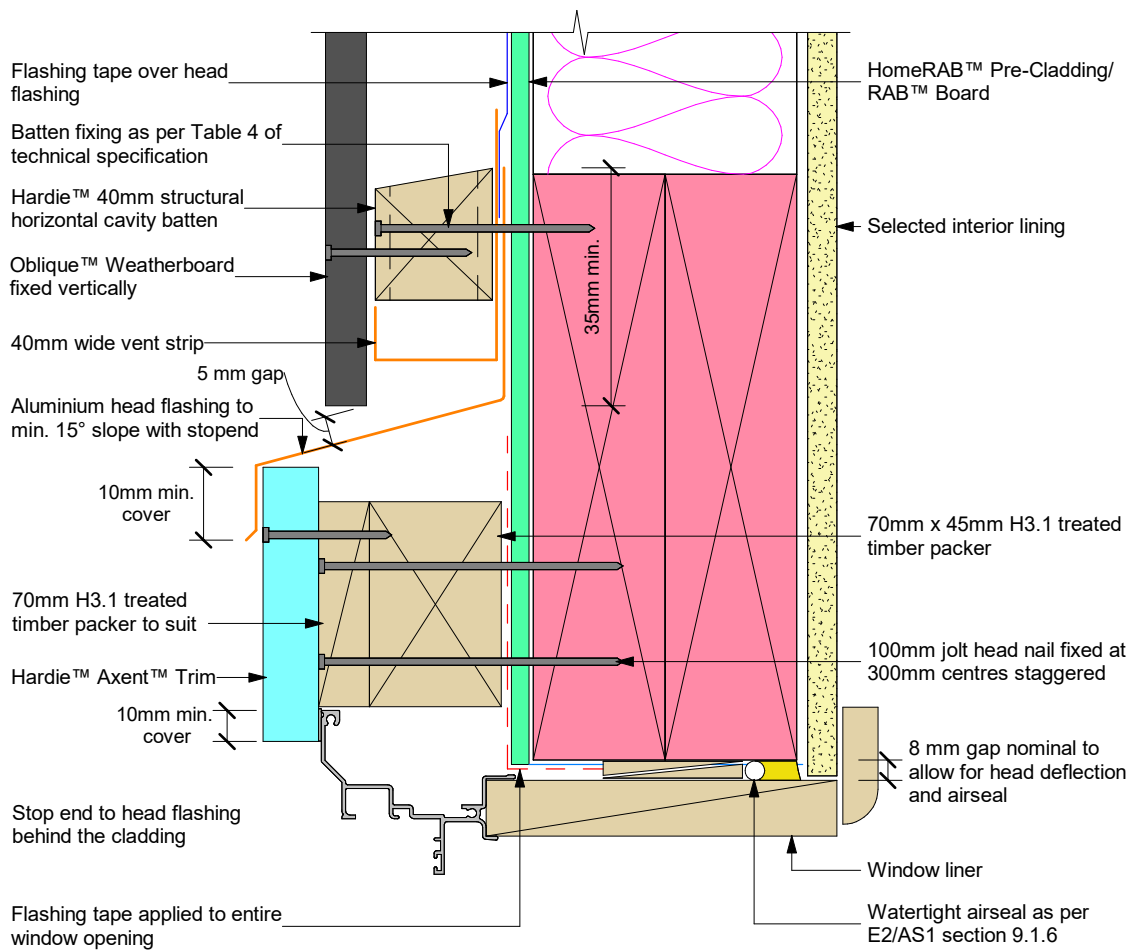

Note:
Sealant must be installed between head flashing and Axent™ Trim in VH and EH wind zones and SED pressures

Figure 20: Door sill support detail

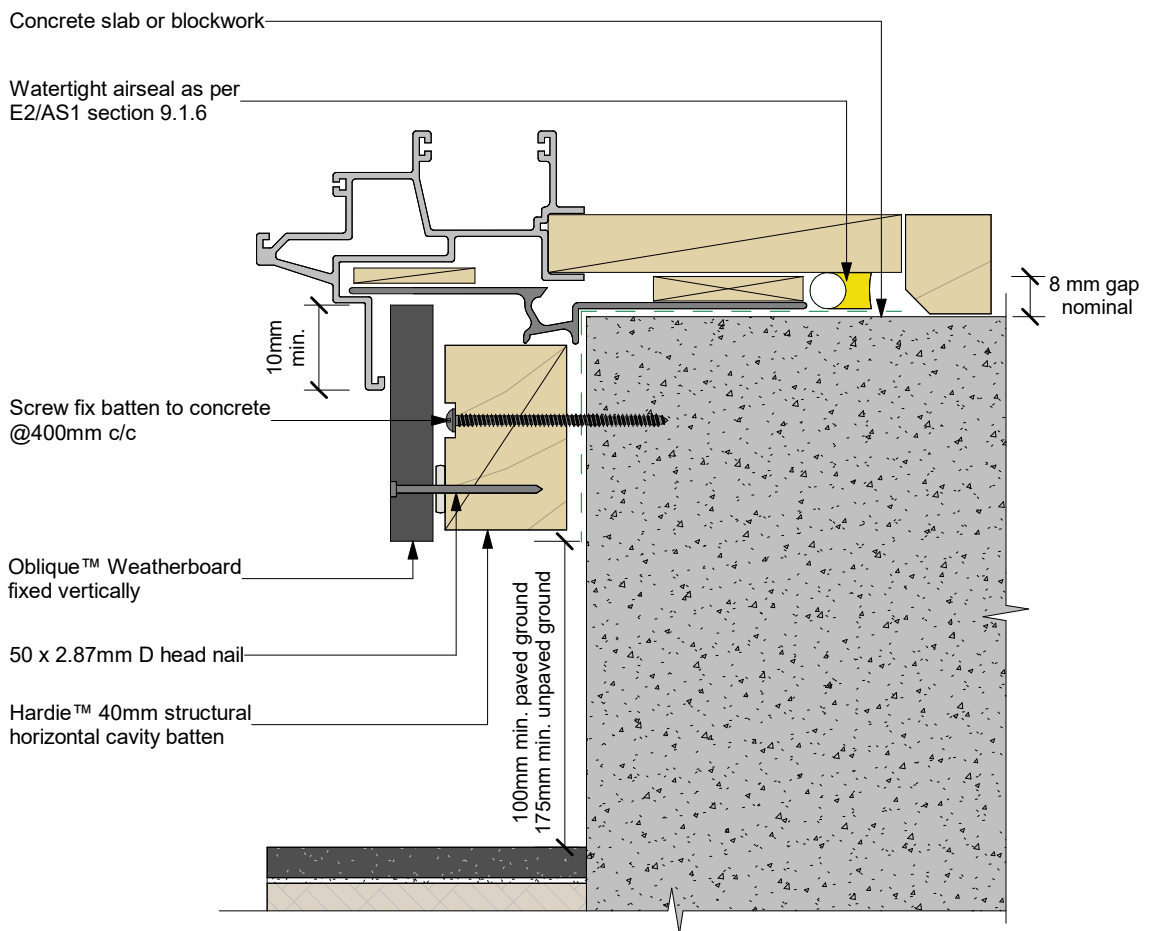

Note: Site cut edges to be primed

Figure 21: Horizontal joint over joist at floor level

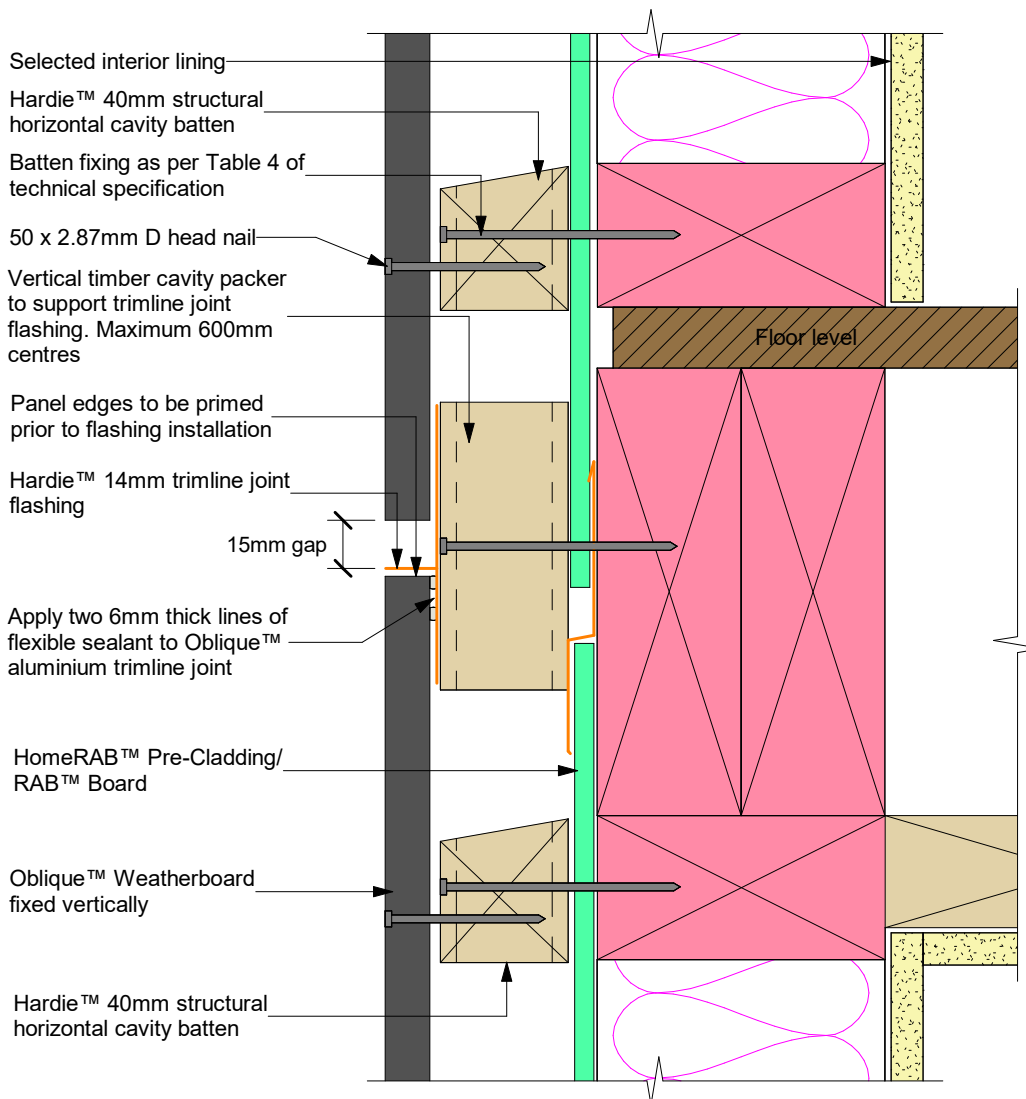

Notes:

- Hardie™ 14mm aluminium trimline joint, take care to ensure continuous seal is formed between panel and the trimline joint
- A Hardie™ supplied 'Trimline Horizontal Joints' flashing will be required over the butt joint of the Hardie™ 14mm aluminium trimline joint
- Site cut edges to be primed
- The flashing to be placed in the centre of the floor joists. Fix cavity battens into floor joists

Figure 23: Trimline joint flashing

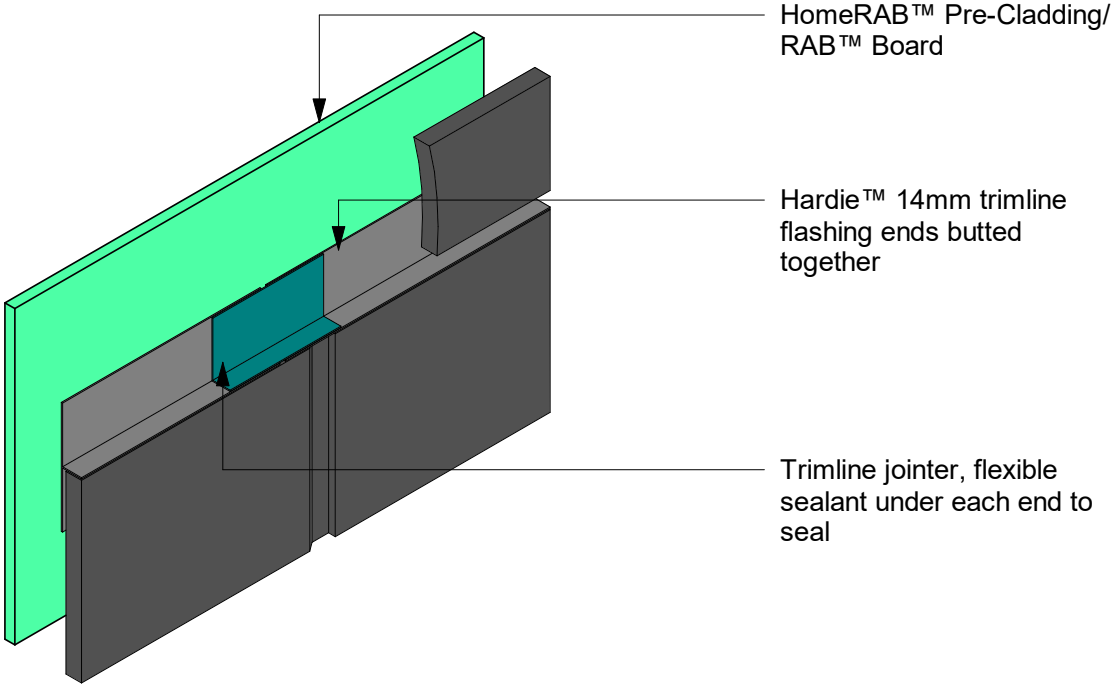

Figure 24: Trimline joint flashing jointing - Option A

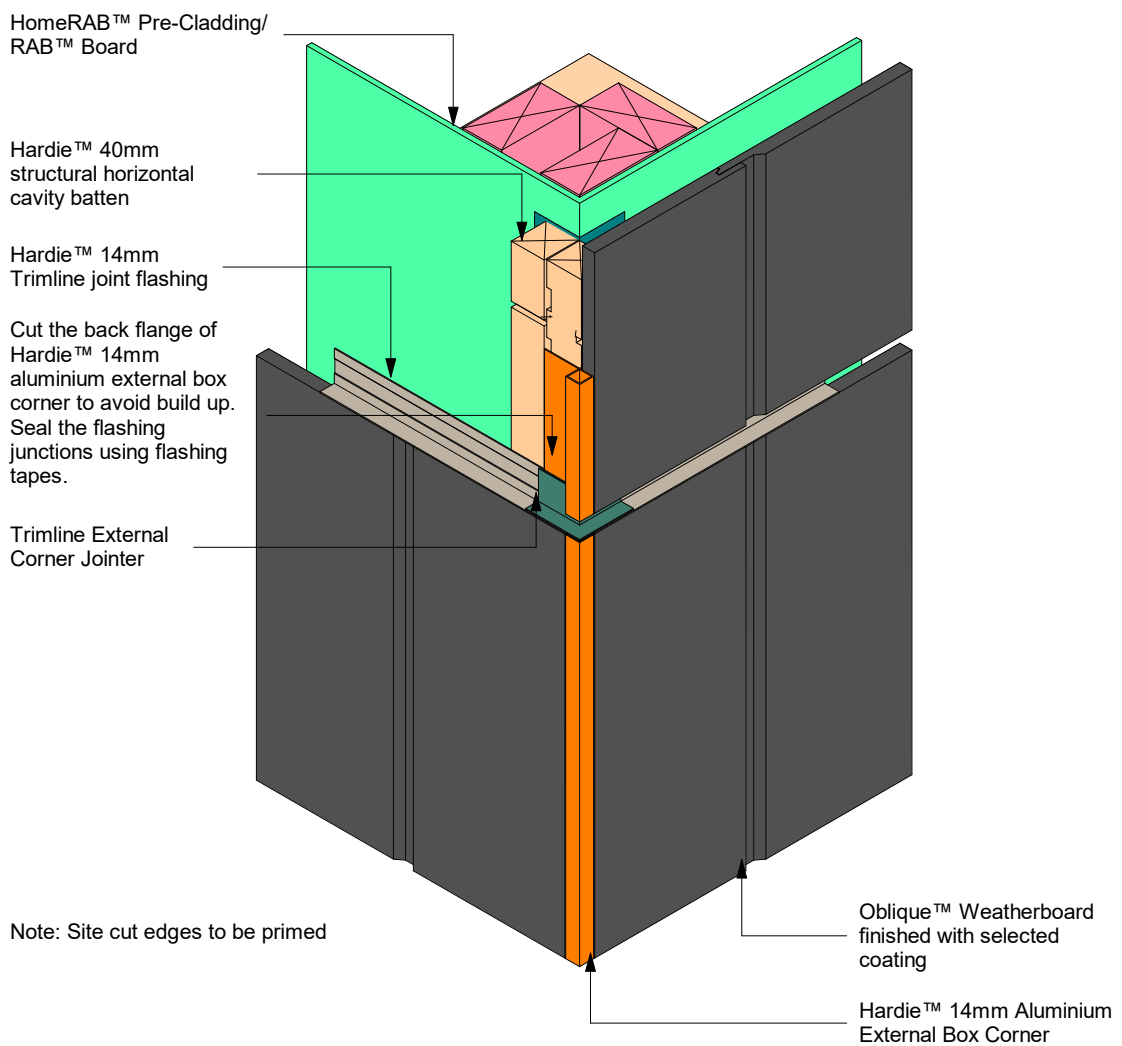

Figure 25: Trimline joint flashing at external corner - Option B

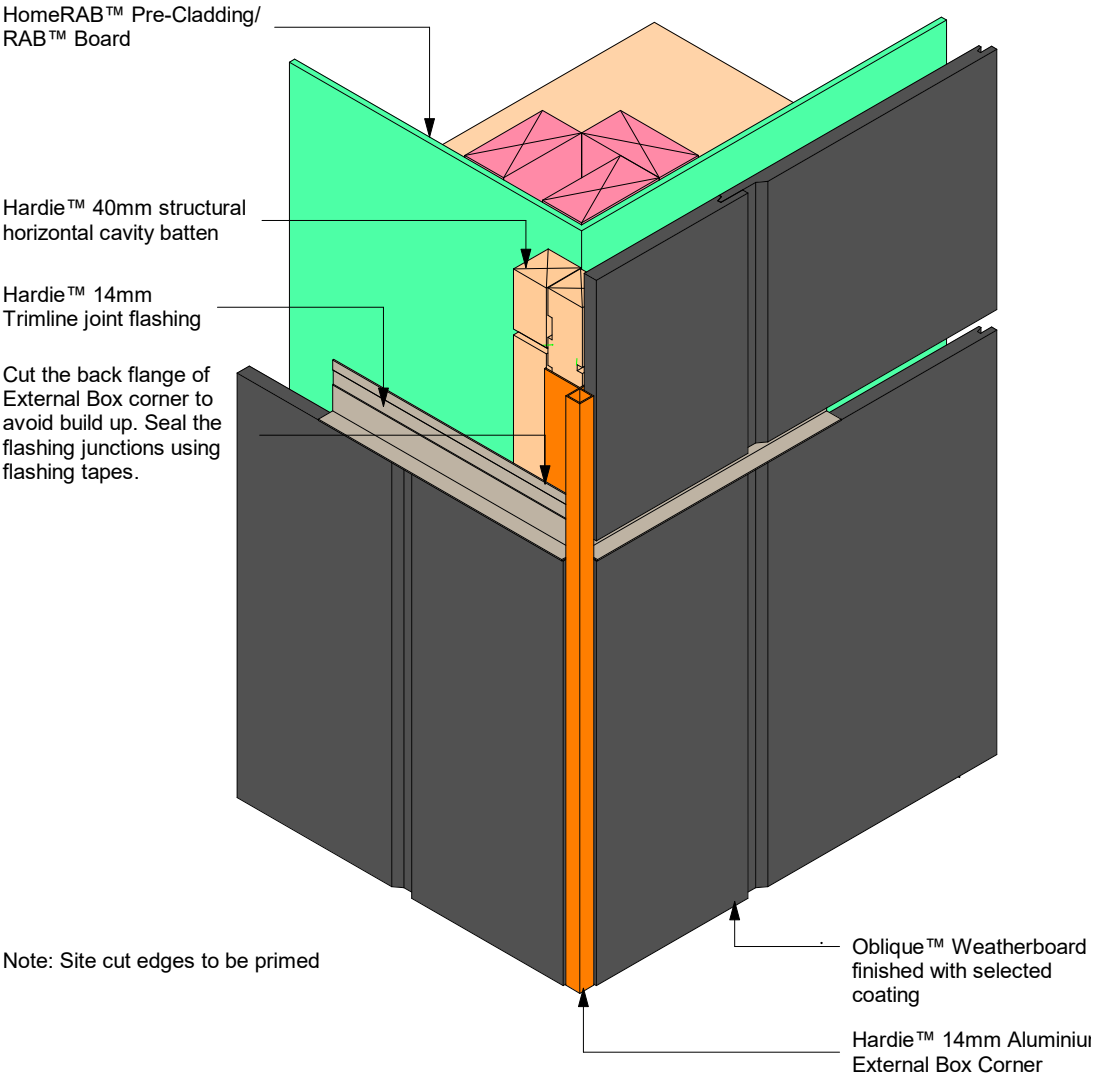

Figure 26: Trimline joint flashing at internal corner

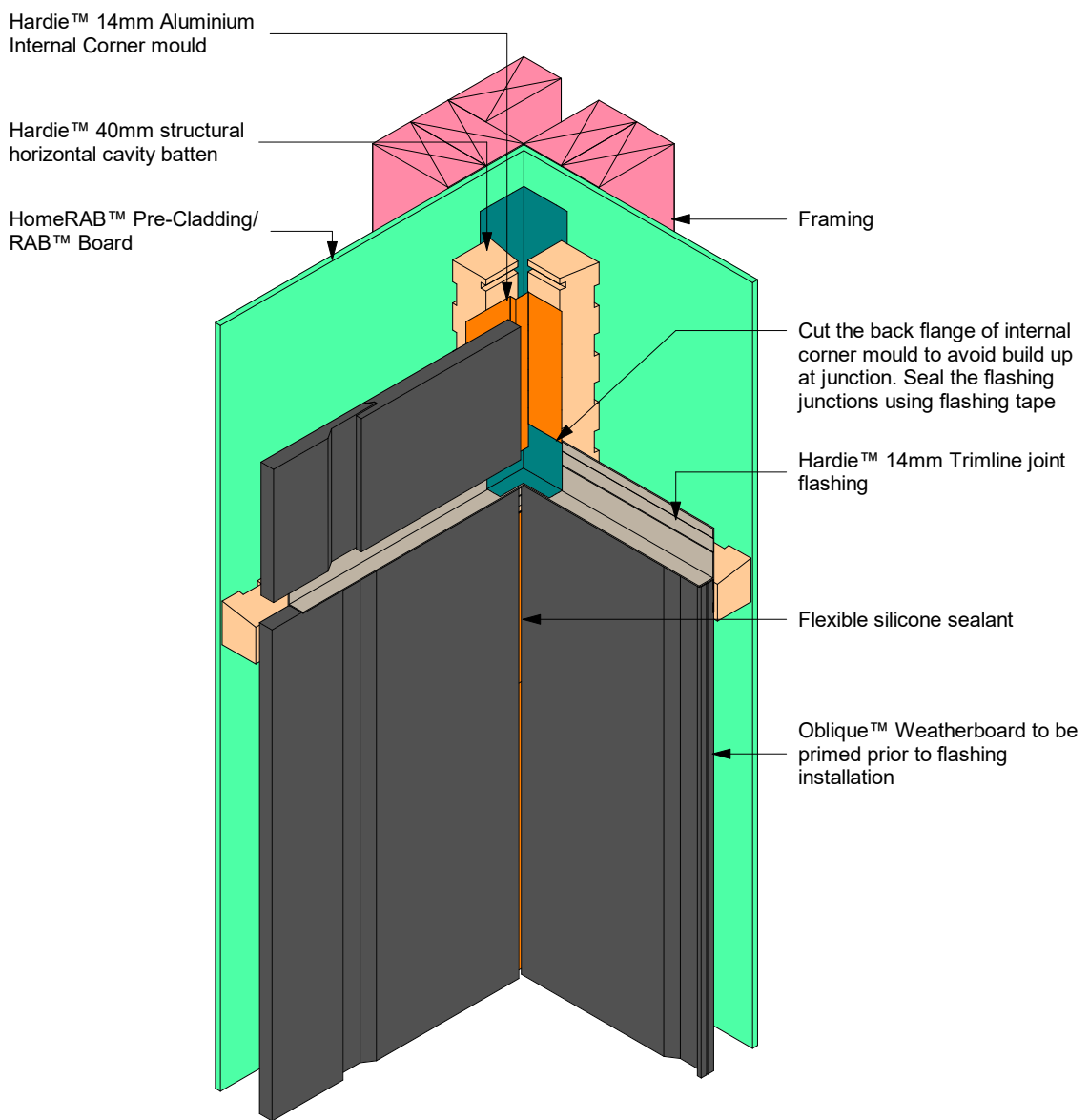
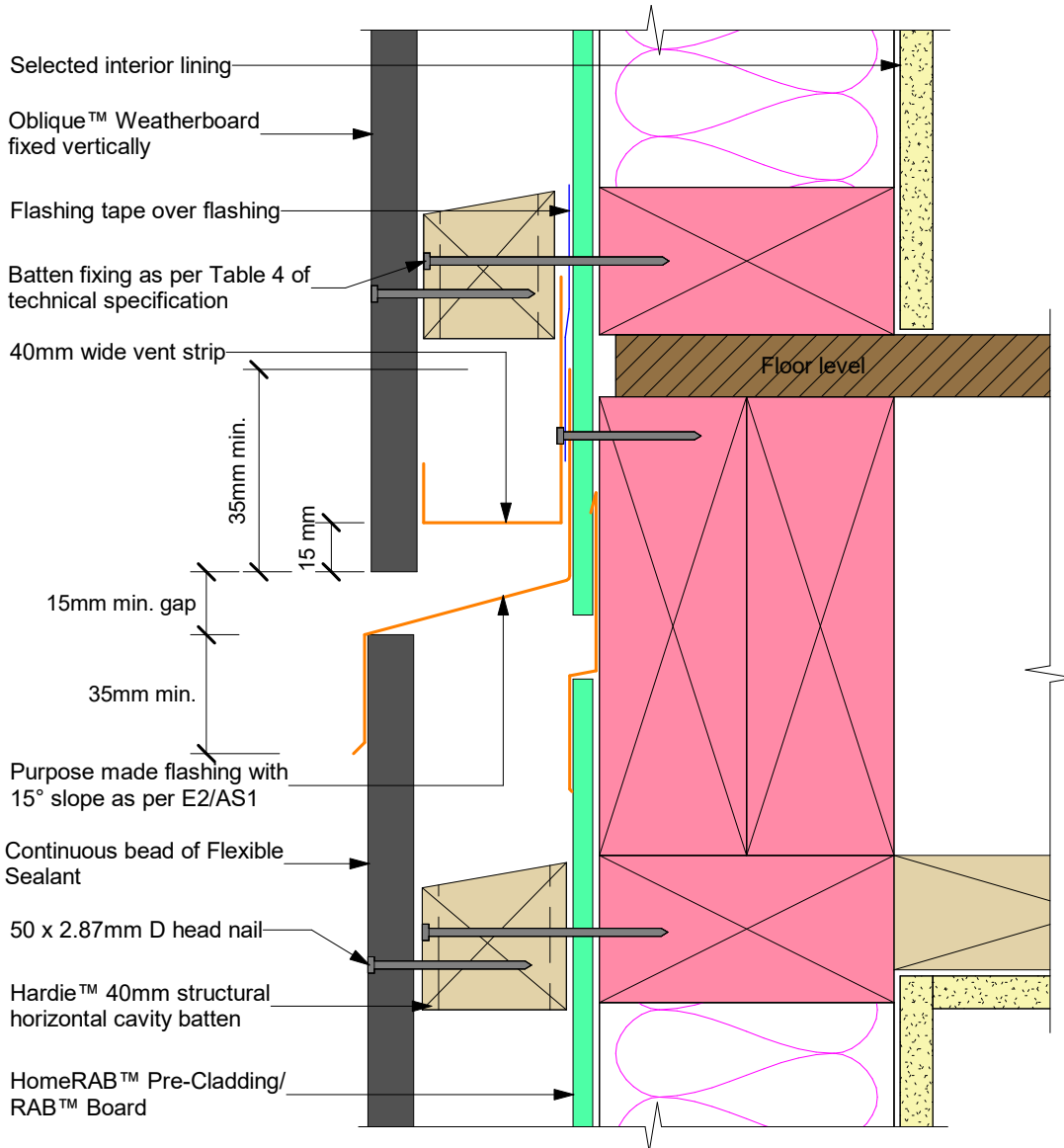

Figure 27: Drained flashing joint at floor level



Note:

- This detail is required to limit cavities to a maximum of 3 stories or 10 metres
- Cut edges need to be primed

Figure 28: Drained flashing joint at external corner

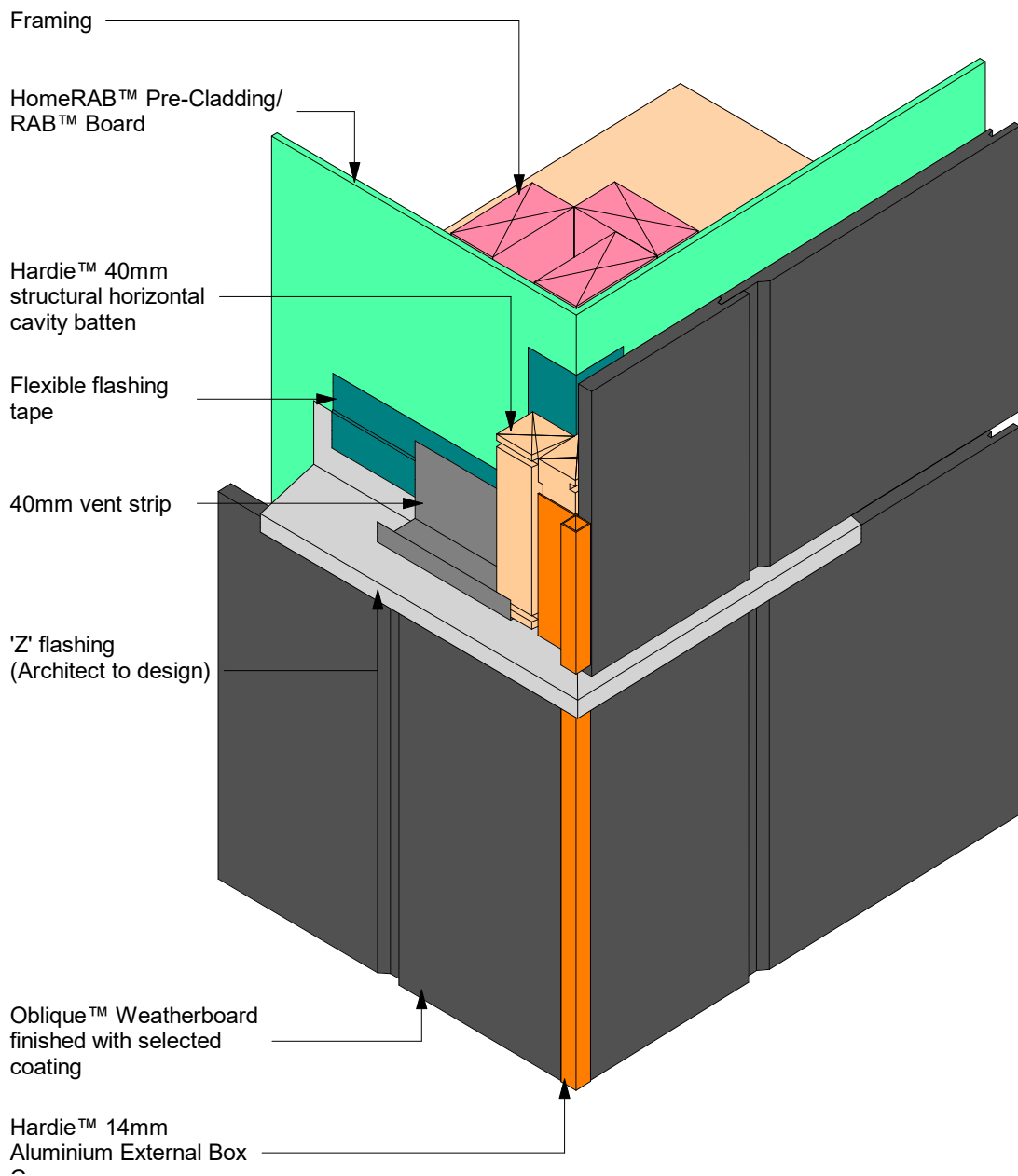
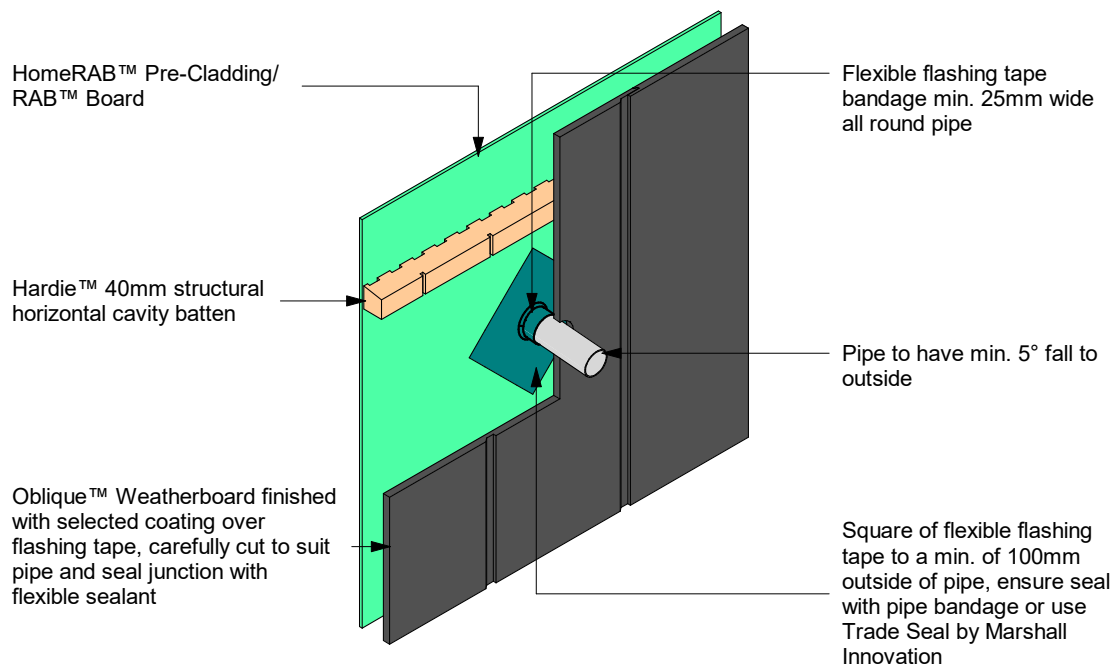
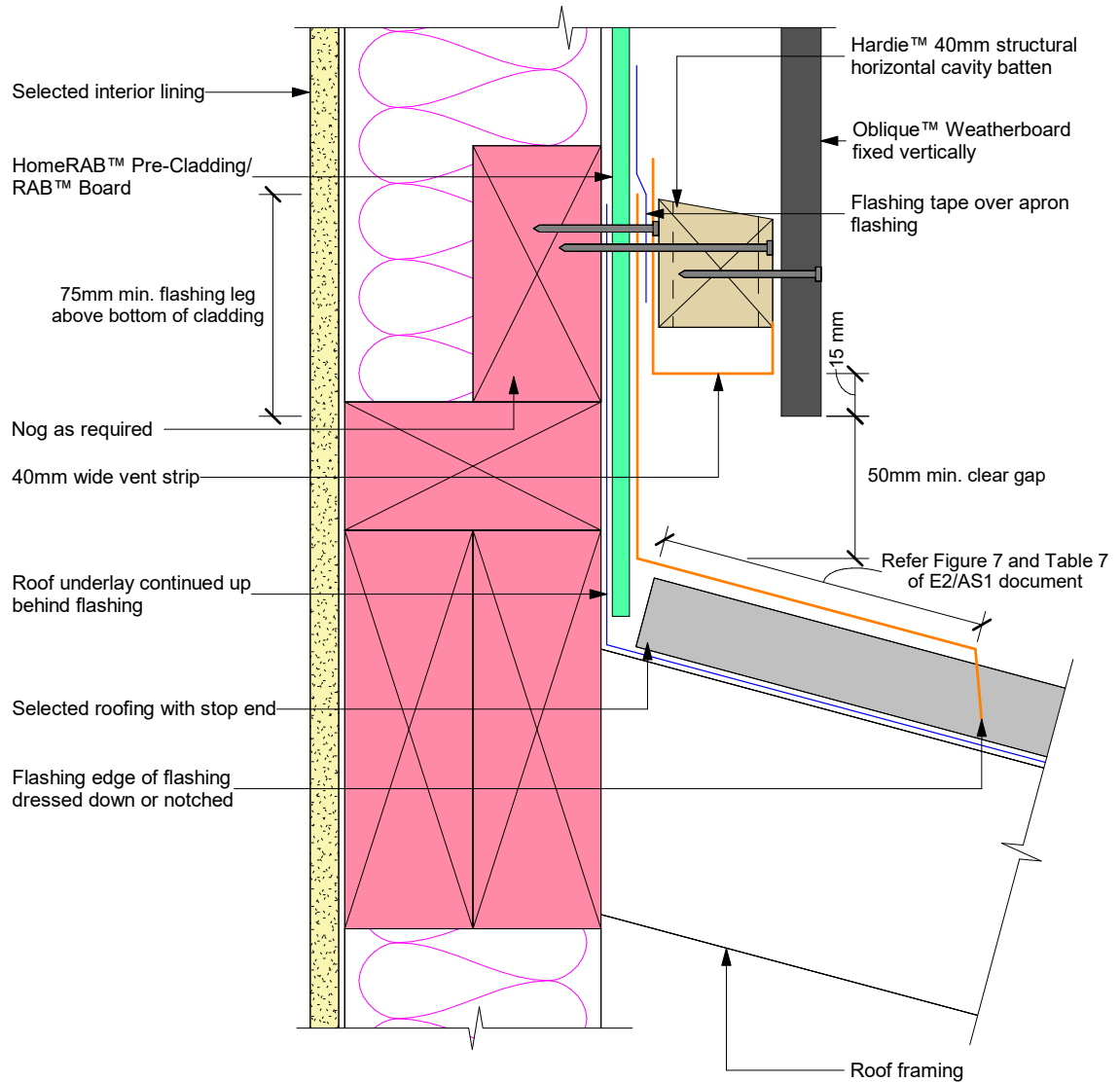

Figure 29: Pipe penetration



Note: Site cut edges to be primed

Figure 30: Apron flashing detail



Notes:

- When 50 year durability for flashing is required refer to Table 20 NZBC E2/AS1 document
- Site cut edges to be primed

Figure 31: Parapet flashing

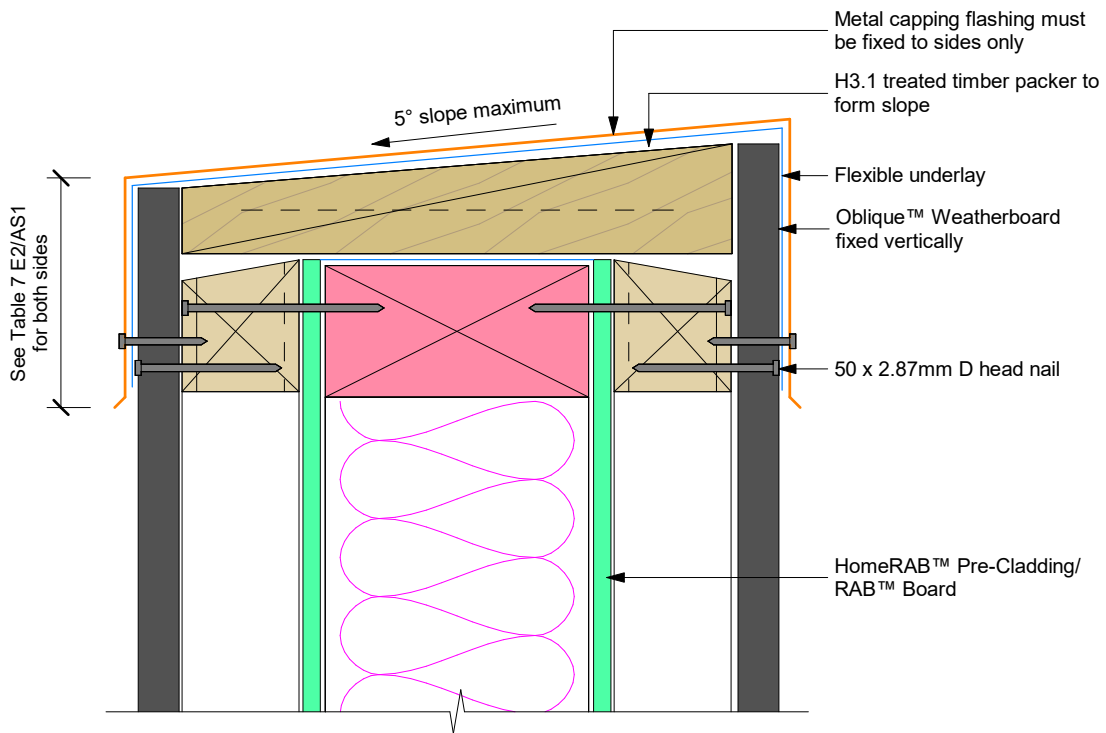
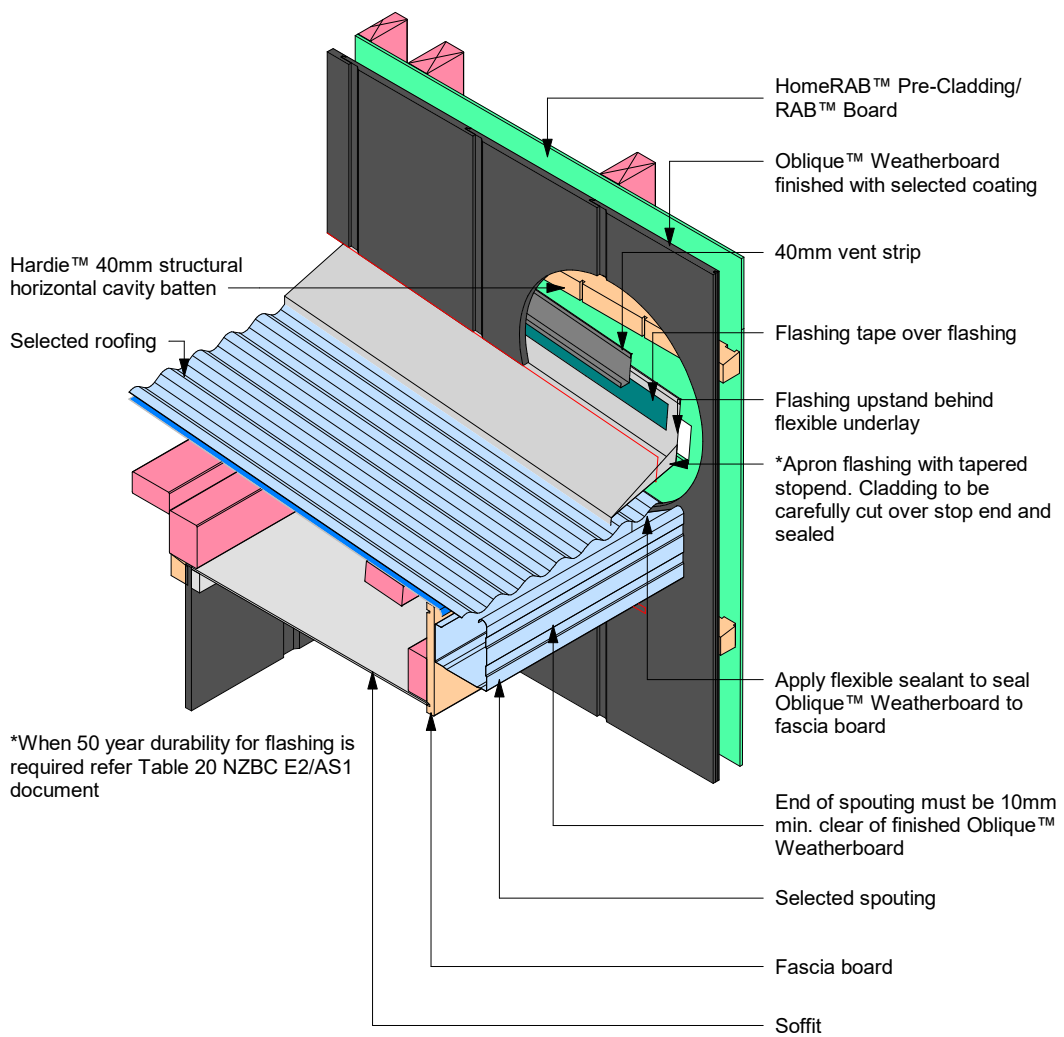
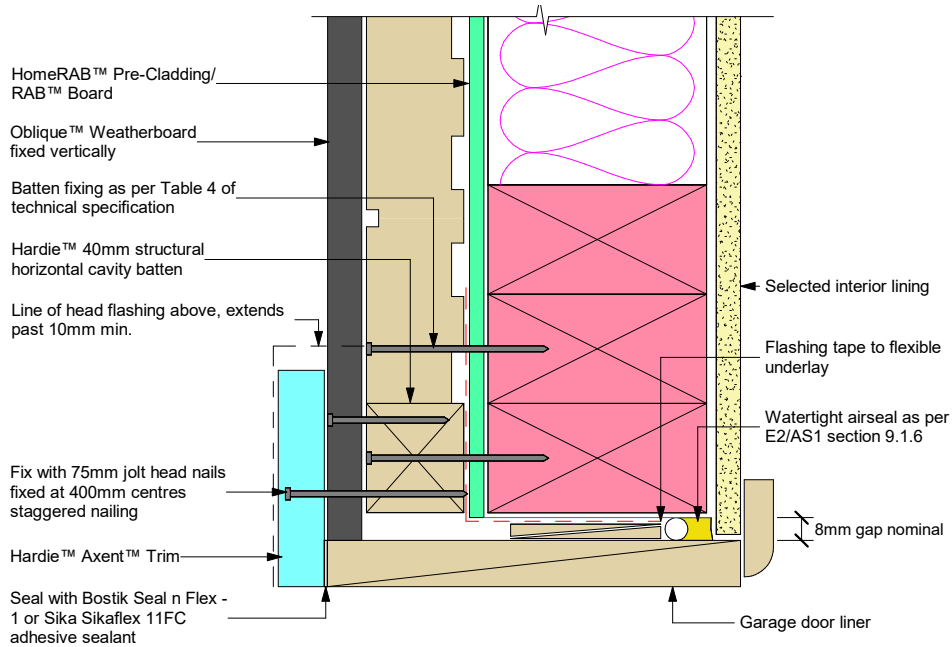

Figure 32: Roof to wall junction detail



Note: Site cut edges to be primed

Figure 33: Garage door jamb



Note: Site cut edges to be primed

Figure 34: Garage door head

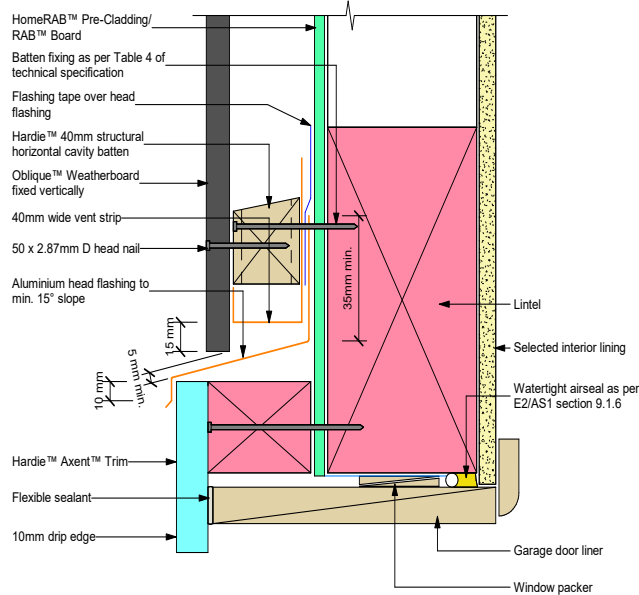

- Sealant must be applied between head flashing and Axent™ Trim in VH and EH wind zones and SED wind pressures
- Site cut edges to be primed

Product Warranty

James Hardie New Zealand Limited (“James Hardie”) warrants for a period of 25 years from the date of purchase that the Oblique™ Weatherboard (the “Product”), will be free from defects due to defective factory workmanship or materials and, subject to compliance with the conditions below, will be resistant to cracking, rotting, fire and damage from termite attacks to the extent set out in James Hardie’s relevant published literature current at the time of installation. James Hardie warrants for a period of 15 years from the date of purchase that the accessories supplied by James Hardie will be free from defects due to defective factory workmanship or materials.

Nothing in this document shall exclude or modify any legal rights a customer may have under the Consumer Guarantees Act or otherwise which cannot be excluded or modified at law.

CONDITIONS OF WARRANTY:

The warranty is strictly subject to the following conditions:

- a) James Hardie will not be liable for breach of warranty unless the claimant provides proof of purchase and makes a written claim either within 30 days after the defect would have become reasonably apparent or, if the defect was reasonably apparent prior to installation, then the claim must be made prior to installation;
- b) this warranty is not transferable;
- c) the Product must be installed and maintained strictly in accordance with the relevant James Hardie literature current at the time of installation and must be installed in conjunction with the components or products specified in the literature. Further, all other products, including coating and jointing systems, applied to or used in conjunction with the Product must be applied or installed and maintained strictly in accordance with the relevant manufacturer’s instructions and good trade practice;
- d) the project must be designed and constructed in strict compliance with all relevant provisions of the current New Zealand Building Code (“NZBC”), regulations and standards;
- e) the claimant’s sole remedy for breach of warranty is (at James Hardie’s option) that James Hardie will either supply replacement product, rectify the affected product or pay for the cost of the replacement or rectification of the affected product;
- f) James Hardie will not be liable for any losses or damages (whether direct or indirect) including property damage or personal injury, consequential loss, economic loss or loss of profits, arising in contract or negligence or howsoever arising. Without limiting the foregoing James Hardie will not be liable for any claims, damages or defects arising from or in any way attributable to poor workmanship, poor design or detailing, settlement or structural movement and/or movement of materials to which the Product is attached, incorrect design of the structure, acts of God including but not limited to earthquakes, cyclones, floods or other severe weather conditions or unusual climatic conditions, efflorescence or performance of paint/coatings applied to the Product, normal wear and tear, growth of mould, mildew, fungi, bacteria, or any organism on any Product surface or Product (whether on the exposed or unexposed surfaces);
- g) all warranties, conditions, liabilities and obligations other than those specified in this warranty are excluded to the fullest extent allowed by law;
- h) if meeting a claim under this warranty involves re-coating of Products, there may be slight colour differences between the original and replacement Products due to the effects of weathering and variations in materials over time.

Disclaimer: The recommendations in James Hardie’s literature are based on good building practice, but are not an exhaustive statement of all relevant information and are subject to conditions (c), (d), (f) and (g) above. James Hardie has tested the performance of Oblique™ Weatherboard when installed in accordance with the relevant Oblique™ Weatherboard technical specifications, in accordance with the standards and verification methods required by the NZBC and those test results demonstrate the product complies with the performance criteria established by the NZBC. However, as the successful performance of the relevant system depends on numerous factors outside the control of James Hardie (e.g. quality of workmanship and design) James Hardie shall not be liable for the recommendations made in its literature and the performance of the relevant system, including its suitability for any purpose or ability to satisfy the relevant provisions of the NZBC, regulations and standards, as it is the responsibility of the building designer to ensure that the details and recommendations provided in the relevant James Hardie installation manual are suitable for the intended project and that specific design is conducted where appropriate.

© 2022. James Hardie New Zealand Limited. TM and ® denotes a Trademark or Registered Mark owned by James Hardie Technology Limited.

