

EI - ROC - 900

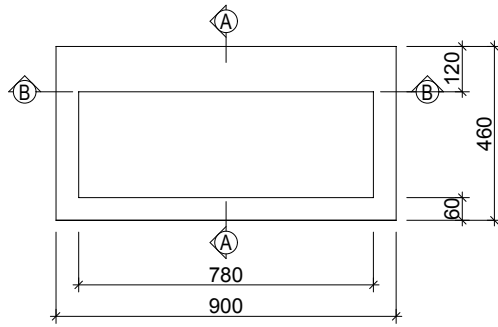

EI - ROC - 1000

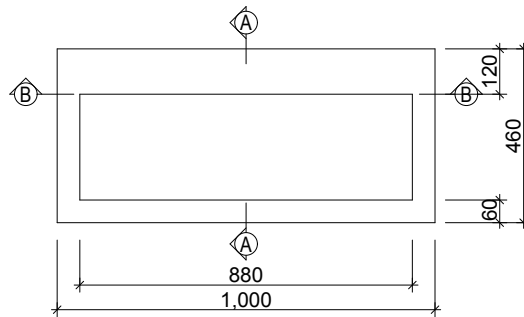

Section A-A

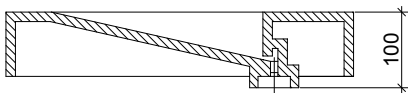

Section B-B

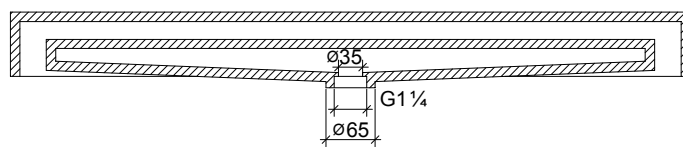

TOP VIEW

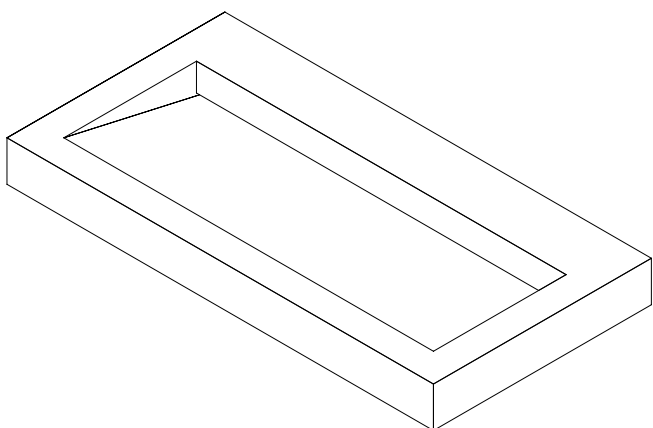

BOTTOM VIEW

