



**Tray-dec**

New Zealand Ltd

# PRODUCT GUIDE

*COMPOSITE STEEL FLOORING SYSTEMS*





# Contents

- 2** About Tray-dec
- 4** Product Introduction
- 5** Tray-dec Design Software
- 6** Composite Slab Design
- 10** Material Specifications
- 11** Using the Span Tables
- 13** Tray-dec 80
- 21** Tray-dec 60
- 29** Tray-dec 300
- 36** NZ Building Code Compliance
- 38** Nelson shear studs and Tray-dec
- 39** Appendix

# About Tray-dec

**Tray-dec NZ Ltd manufactures three profiles of steel composite flooring; two trapezoidal profiles and one flat profile.**

All profiles are shaped to interlock with adjacent trays to act as both tensile reinforcement and permanent formwork for a concrete slab. The composite action of the steel and the concrete deliver a strong floor that is light in weight.

With the assistance of OBD Consultants and Auckland University of Technology, Tray-dec products were laboratory tested to ensure compliance with the latest building standard in composite structures, AS/NZS 2327:2017.

Tray-dec has introduced an Excel based design software to assist designers to carry out a complete composite slab design. This software is available to all designers on request.



*This brochure is valid on date of publication. All span tables are determined from the most current version of this software. Users are advised to check the Tray-dec website for the latest version of the design software.*





*Residential project –  
Mangawhai, Northland  
using Tray-dec 300*





# Product Introduction

## TRAY-DEC 80

**Tray-dec 80** is the strongest Tray-dec profile. This profile allows for longer spans and thicker slabs, maximising strength and fire ratings. Longer spans minimise the requirements for support beams. The minimum slab thickness on Tray-dec 80 is 130mm.

*Designs are in accordance with AS/NZS 2327:2017*

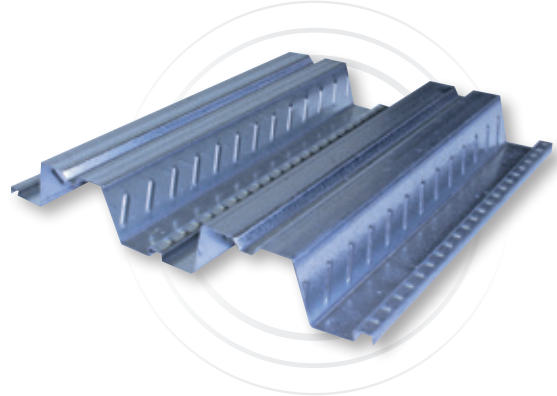

## TRAY-DEC 60

**Tray-dec 60** is an intermediate decking solution with mid-range spanning capabilities. It is lighter and a lower cost than larger profiled composite decking. The minimum slab thickness on Tray-dec 60 is 110mm.

*Designs are in accordance with AS/NZS 2327:2017*

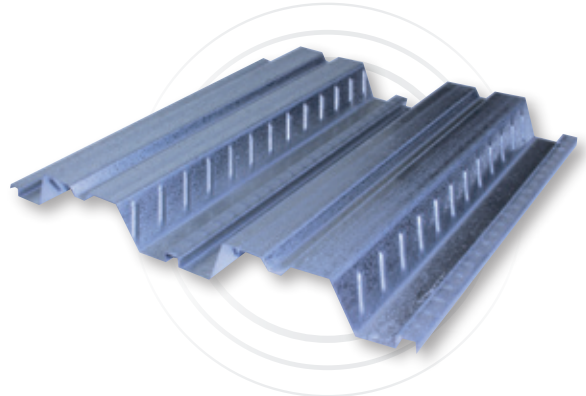

## TRAY-DEC 300

**Tray-dec 300** is a flat soffit composite deck which interlocks with adjacent trays. The design allows for a uniform slab thickness resulting in a significant acoustic advantage. The minimum slab thickness on Tray-dec 300 is 100mm.

*Designs are in accordance with AS/NZS 2327:2017*

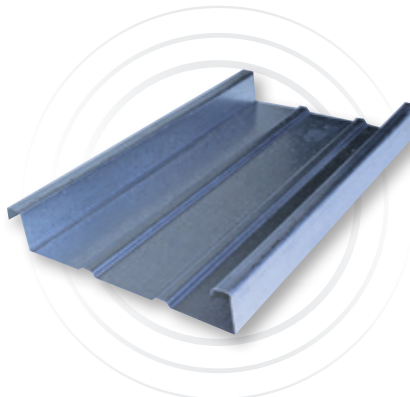



# Tray-dec Design Software

The Tray-dec composite floor design software is an Excel based programme written to comply with the new composite structures standard AS/NZS 2327:2017.

All span tables and technical information presented in this product guide are derived from this programme.

Simply enter the required spans and loads and adjust floor parameters to design the floor to meet the code

for each Tray-dec profile. Parameters such as additional point loads, reinforcing steel and fire resistance rating can be taken into account. The calculations run automatically on a single screen and clearly indicate where the structural capabilities are exceeded.

Tray-dec software is available through a simple registration process. Users will then be emailed the programme and instructions.

For hands on support when using the Tray-dec software contact us at **09 820 9133**.

**Tray-dec Design Software**  
Version 2019.0 (Sept 2019)

Job Name: \_\_\_\_\_ Date: 18.07.2019 Page 1/2  
 Site Address: \_\_\_\_\_ Job No.: 19000 Designer: SL  
 Consulting Engineer Company: \_\_\_\_\_ Checker: TOB

**Input**

Project location: Auckland  
 Profile: Tray-dec 80 - 1.21  
 Slab usage: Floor-Residential and domestic  
 Slab plate: Residential (related to vibration check)  
 Design working life: 50 years (For vibration analysis, consider an entire level)  
 Effective floor area: 500 m<sup>2</sup>  
 Soffit requirements: No visual quality

Concrete type: Normal Weight  
 Concrete grade: C30

Span type: Multi  
 Span: 3 m (Distance between centres of permanent supports)  
 (Only when cantilever or unequal double span)  
 Check: **OK**

Slab depth: 200 mm  
 Finishes depth: 0 mm  
 Support width: 250 mm (Typically 100mm-500mm)

Deck propping: No  
 Deck prop width: 200 mm (Typically 50mm-250mm)

Uniform imposed load: 10.0 kPa  
 Uniform permanent SDL load: 0 kPa (Ceiling/Service/Finish/Partition/Others)  
 Concentrated actions: 0 kN (Refer NZS 1170, checking punching shear only)

Additional point load: None (If any to be combined with UDL, normally 0)  
 Load width: 0 mm (Not relevant if no additional point load)  
 Load length: 0 mm (Perpendicular to the deck span)  
 Location of the load: 0 mm (Parallel to the deck span)  
 (The centre of load from center line of nearest support)

Mesh layer: Single  
 Mesh type: SEB15  
 Min. top cover to all steel: 30 mm (Typically 15mm-45mm)  
 Check: **OK**

Additional top rebar: None (Longitudinal)  
 Rebar above mesh: Rebar above mesh (Not relevant if no additional top rebar)  
 Check: **OK**

Fire resistance rating: None (at 300mm spacing)  
 Fire resistance bottom rebar: None mm (Typically min. 25mm, max. steel profile height)  
 Rebar deck bottom cover: 45 mm (Thermal actions arising from the fire)  
 Fire load: 0 kPa (during the FRR time, leave it blank if unsure)  
 Max. Temp. on steel deck: \_\_\_\_\_ °C

This design software was developed by OBD Consultants by Shawn Jianshan Li (B.Eng M.Engst) under the supervision of Tony O'Brien (BSc [Eng] Dip Eng MIEI CMEngNZ CPEng IntPE [NZ]).

This software has successfully been appraised by BRANZ. See appraisal number 841 [2019].



Mason Apartments – Otahuhu, Auckland  
using Tray-dec 80



# Composite Slab Design

## INFORMATION FOR USING ALL TRAY-DEC PRODUCTS

The design of a composite slab requires the consideration of two factors:

1. Structural capabilities of the steel deck alone during the construction stage (i.e. wet concrete being placed, no composite action);
2. Structural capabilities of the composite floor slab, whereby the steel deck acts as reinforcement to the cured concrete slab.

### 1. STRUCTURAL PROPERTIES OF STEEL TRAY DURING CONSTRUCTION

In the construction phase of the floor slab, Tray-dec sheets support the weight of the wet concrete plus additional construction loads (live loads). Maximum allowable spans are limited by the following criteria:

#### A. SHEAR AND BENDING

- i. Shear and bending checks are in accordance with NZS 4600:2005.
- ii. Hogging moment is only considered when designing Tray-dec over double and multiple spans. Hogging is also considered with single spans using propping and cantilevered sections with no propping.







## B. DEFLECTION

- i. Maximum allowable deflection of Tray-dec sheets are limited by the lesser of the effective span ( $L_e$ )/130 or 30mm.  $L_e$  is defined in AS/NZS 2327, Clause 2.6.
- ii. Ponding is taken into consideration if the maximum deflection of the sheeting under its own weight plus concrete and reinforcing, and calculated for serviceability, is greater than 10% of the intended slab depth.

### NOTES:

1. Live loads (imposed actions) consist of:
  - A. Loads during the concrete pour.
    - i. The weight of the concrete is assumed to be a uniformly distributed load of the design thickness plus ponding (when applicable).
    - ii. Working personnel with tools is assumed to be a uniformly distributed load of 0.75 kPa outside the working area.
    - iii. Inside a 3x3m working area (or span length if span is less) an additional construction load of 0.1 times the self-weight of the fresh concrete at the design thickness of the floor is to be taken into consideration during the casting of the concrete.
  - B. Loads due to storage of movable items. The greater of 1.5 kPa or the actual storage load will be used.
  - C. Loads due to non-permanent construction equipment. The greater of 0.5 kPa or the actual non-permanent load will be used.
2. Concrete density has been taken as 2400 kg/m<sup>3</sup> when wet. The concrete used must be high grade as defined by NZ3109:1997.
3. When the soffit requires a good visual surface, spans have been calculated to ensure the deflection under the load of wet concrete does not exceed the lesser L/240 or 20mm.
4. Bearing on steel or concrete must be no less than 50mm. On other building materials bearing must be no less than 70mm.

## 2. STRUCTURAL PROPERTIES OF THE COMPOSITE SLAB

Tray-dec floors are designed as one-way concrete slabs where the steel deck acts as tensile reinforcement. The composite slab must withstand the combined effects of dead and live loads as specified by the designer. Load values are specified in AS/NZS 1170.1:2002. The total load on a floor is defined as the sum of:

- A. Dead load due to the weight of the composite slab;
- B. Superimposed dead load;
- C. Live loads.

The calculation of maximum spans of Tray-dec sheets in composite action are based on the following criteria:

### A. SHEAR AND BENDING

- i. Shear and bending checks are in accordance with NZS 3101:2006, AS/NZS2327:2017 and BS 5950-4:1994. Longitudinal shear strength values have been derived from the standard testing procedures carried out to AS/NZS 2327 appendix H to calculate the bending check.

### B. PUNCHING SHEAR

- i. Punching shear resistance or a concentrated loads and point loads are determined by NZS 3101.

### C. DEFLECTION

- i. Maximum spans are to be less than the span (L)/250. Composite stage deflection is defined in NZS 2327, section 2.8 as the calculated sum of:
  1. Short term deflection;
  2. Creep deflection;
  3. Shrinkage deflection.
- ii. End anchors in Tray-dec sheets are assumed to ignore end slip.
- iii. Cantilever spans assume the overhang as a cantilever beam (one end free and one end fixed).

### D. FIRE RESISTANCE

- i. Minimum thickness of normal concrete for insulation is defined in table 7.7.2.2 of AS/NZS 2327.





*Harington Street Carpark –  
Tauranga, Bay of Plenty  
using Tray-dec 80*



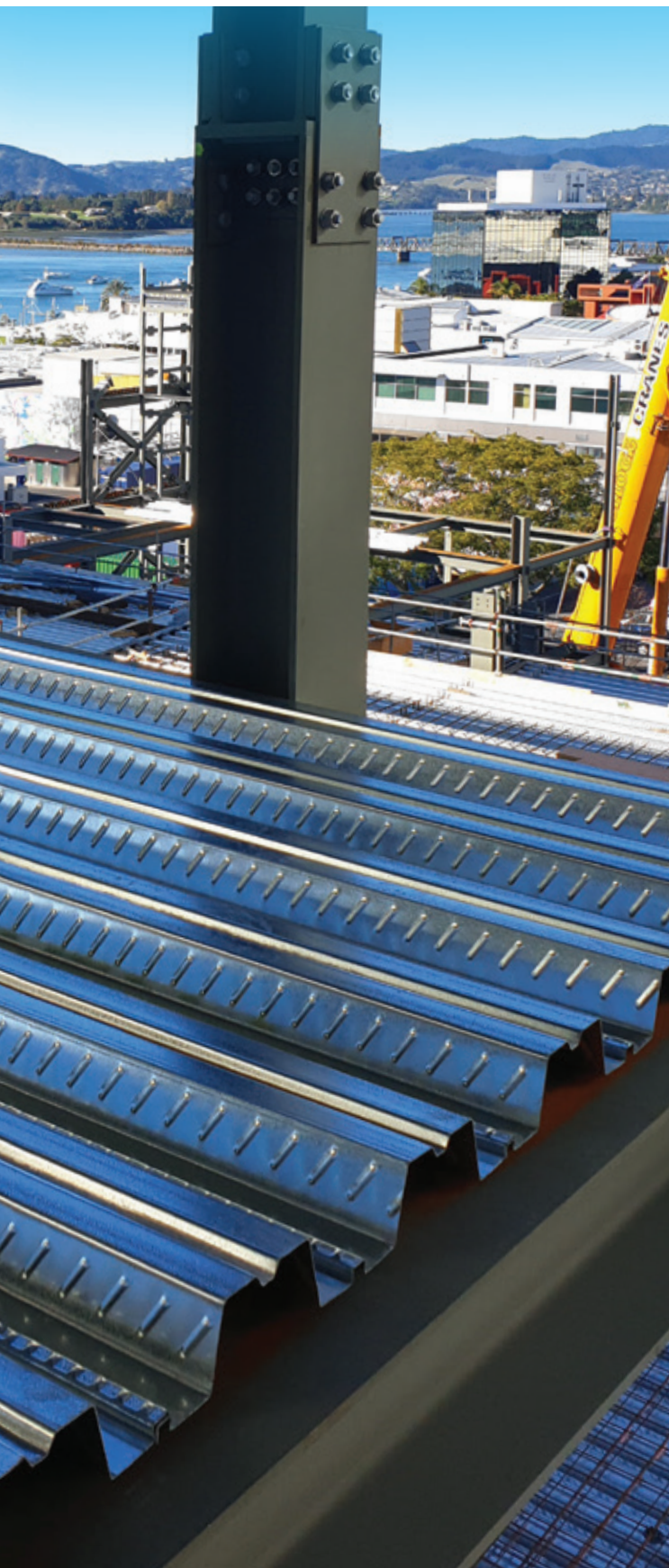

- ii. Sagging and hogging moment capacities are checked.
- iii. For sagging moment capacity, the contributions of fire reinforcement, mesh reinforcement and steel deck are calculated separately and the largest value is adopted.

#### E. VIBRATION

- i. As recommended by AS/NZS 2327 clause 6.4.1, the vibration check is calculated in accordance with ES ISO 10137:2012.
- ii. It is recommended that the vibration analysis is checked by the designer.

#### NOTES:

1. For cantilever sections, only overhangs with one back span is analysed where just the overhang section is checked for deflection and fire resistance.
2. It is assumed that the back span is at least double the length of the overhang for cantilever sections. Only the downward deflection for overhang is considered.
3. The weight of cured concrete is assumed to be 2350kg/m<sup>3</sup>.
4. Floor openings require additional reinforcing specifically designed for the project. Tray-dec sheets are not to be cut until the concrete is fully cured. Openings will compromise the strength of the composite floor and should be subject to specific design.
5. Secondary reinforcement is required in all cases to control surface shrinkage cracking as per AS/NZS 2327 clause 6.3 and clause 2.4.3 (page 30). Refer NZS 3101 to confirm the exposure classification and the cover for reinforcing mesh.
6. Nelson shear studs are used in composite floor design and require an individual design plan. Refer to the Appendix for more detailed information about Nelson shear studs.





# Material Specifications

All Tray-dec products are cold rolled from high strength zinc coated steel coil conforming to AS 1397-2011 base grade G500. All coatings are to class Z275, giving a minimum coating mass of 275g/m<sup>2</sup>.

Our profiles are available in three thicknesses; 0.75mm and 0.95mm for Tray-dec 60 and Tray-dec 300, and 0.95mm and 1.2mm for Tray-dec 80. The minimum yield strengths for each thickness are: 550 MPa for 0.75mm, 520 Mpa for 0.95mm and 500 Mpa for 1.2mm. Tray-dec products can be supplied in any length, subject to the limitations of available transport and safe manual handling.



# Using the Span Tables

**In the following sections, span tables are provided for each profile. The span tables determine the maximum span allowable during construction and after the concrete is cured. Each table includes maximum allowable spans for different imposed loads and slab depths.**

Where the maximum span is governed by deflection during construction, an arrow in the composite table indicates that the maximum construction stage span is to be used. If the span is governed by the intended imposed load, the maximum allowable span will be indicated in the composite table under the appropriate imposed load.

The values of span in the composite stage section are further influenced by the deflections resulting from the weight of live load plus dead load. The allowable deflection is a function of span/250.

Deflection calculations in the construction stage take into consideration all loads stated in Appendix A Section 4 of AS/NZS 2327. Deflection calculations for the slab in composite action come into effect once the concrete has cured to at least 15 mPa and are derived from NZS 2327 2.8.3. Concrete loads are calculated by the given values of concrete weight/m<sup>2</sup> indicated by Tables 1, 2 and 3 on the following pages.

All spans assume a support width of 150mm where span values are from centreline to centreline of the beam flanges. Propped spans assume a 100mm prop width.

In addition to the span tables, deflection graphs are included. These graphs show the deflection (in mm) of the decking as a function of span (in m). If the Tray-dec is being installed within its allowable span distance, refer to these graphs to determine the resulting deflections to see if propping is desired. Graphs include different slab thicknesses.







Wynyard 100 –  
Auckland City  
using Tray-dec 80



# Tray-dec 80



**Tray-dec 80** is a trapezoidal style of composite flooring and the strongest Tray-dec profile. This profile allows for longer spans and thicker slabs, maximising strength and fire ratings. Longer spans minimise the requirements for support beams. The minimum slab thickness is 130mm using Tray-dec 80.

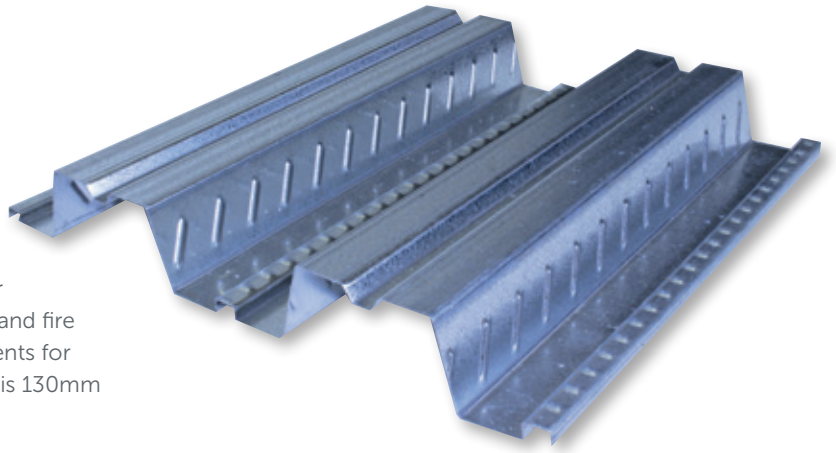

*Designs are in accordance with AS/NZS 2327:2017*

## Design

Adjacent sheets are joined along the overlapping edge using self-tapping screws. The inverted (rather than re-entrant) top rib maximises concrete cover for a given slab thickness and increases strength in composite action.

## Quality Materials

All Tray-dec 80 is rolled from high strength zinc-coated steel coil in compliance with AS 1397-2011. Tray-dec 80 profiles are made from grade G500 steel and are available in either 0.95mm or 1.2mm thickness. Construction and composite span tables are provided for each grade.

*Below: Ramada Queenstown – Queenstown, Otago using Tray-dec 80*

## Longer Spans

Multi-span trays are able to span up to 4.9 metres unpropped and over 8 metres propped depending on slab thickness. Longer spans require less support beams and allow larger beam spacing.

## Nelson Shear Stud Placement

Symmetrical interlocking trays allow for simple and even placement of Nelson shear studs. Studs welded through deck optimise composite properties of the slab.

## Accessories

Accessories to complete necessary formwork include internal and external end caps, folded metal edge form to suit the slab thickness and closure plates.





# Tray-dec 80

## TRAY-DEC 80 CAD DRAWING

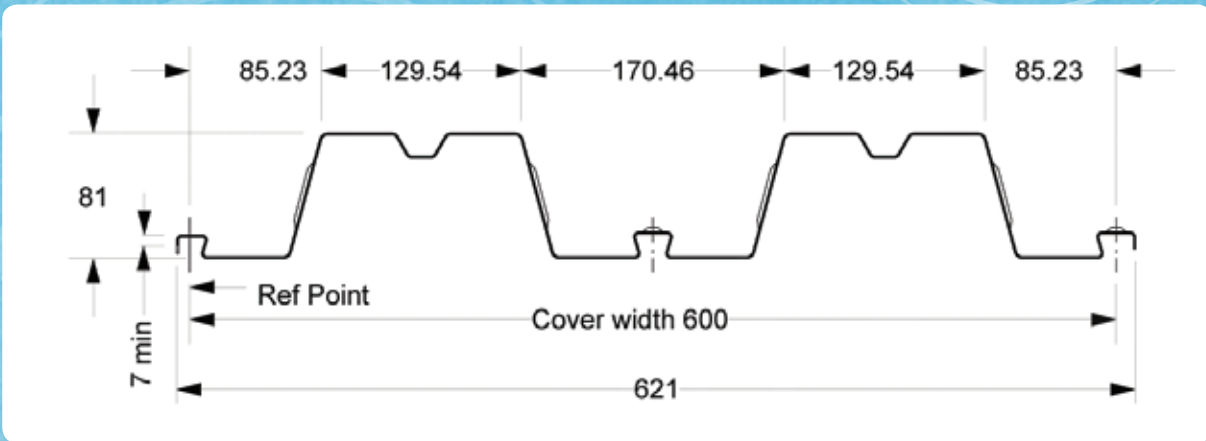
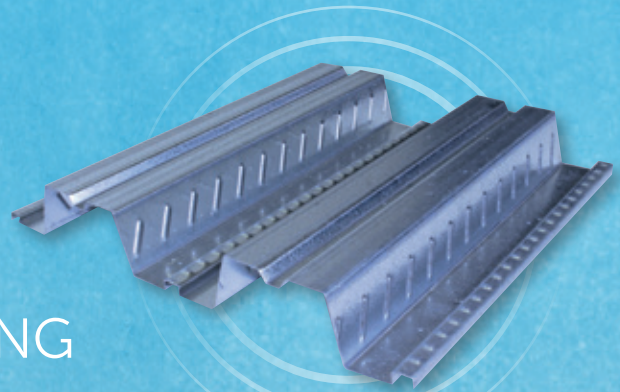

### Tray-dec 80 - Section Properties (per metre width)

Section Thickness (mm)	Design Mass (kg/m <sup>2</sup> )	Profile Weight (kN/m <sup>2</sup> )	Cross Section Area (mm <sup>2</sup> /m)	Height to Neutral Axis (mm)	Moment of Inertia (cm <sup>4</sup> /m)	Ultimate Moment Capacity (kNm/m)
1.2	15.15	0.15	1944	38.16	203.7	23.79
0.95	11.99	0.12	1547	38.01	162.6	19.66

### Tray-dec 80

Volume & Weight of Concrete (kN/m<sup>2</sup>) Table 1

Slab Depth (mm)	Volume (m <sup>3</sup> /m <sup>2</sup> )	Normal Weight Wet	Concrete Dry
130	0.090	2.16	2.12
140	0.100	2.40	2.35
150	0.110	2.64	2.59
160	0.120	2.88	2.82
170	0.130	3.12	3.05
180	0.140	3.36	3.29
190	0.150	3.60	3.52
200	0.160	3.84	3.76
220	0.180	4.32	4.23
240	0.200	4.80	4.70
260	0.220	5.28	5.17

#### TABLE ASSUMES THE FOLLOWING:

1. The weight of concrete is 2400kg/m<sup>3</sup> (wet) and 2350kg/m<sup>3</sup> (dry).
2. Weight of deck, mesh and reinforcing is not included.
3. No ponding has been allowed.





*Ramada Queenstown –  
Queenstown, Otago  
using Tray-dec 80*



# Tray-dec 80: $t = 0.95$

## CONSTRUCTION DEFLECTION GRAPHS

**NOTE:** Span values are from centreline to centreline of supports based on a beam flange width of 150mm.

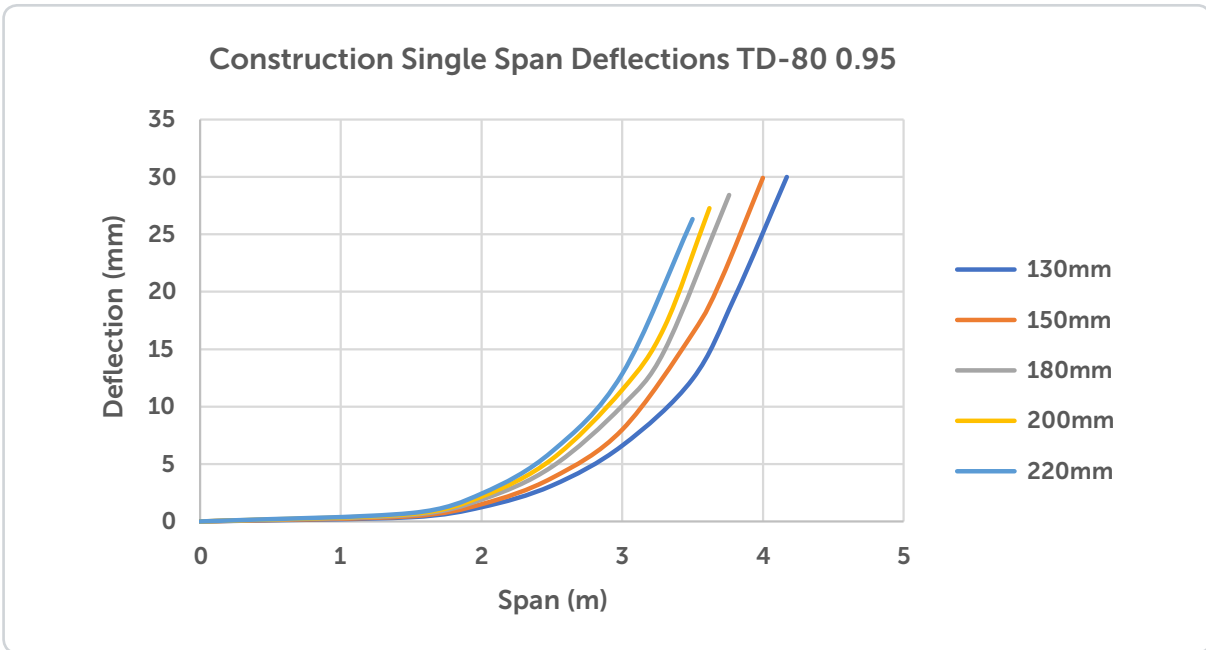

Tray-dec 80 0.95mm single span deflections as a function of span length for different slab depths

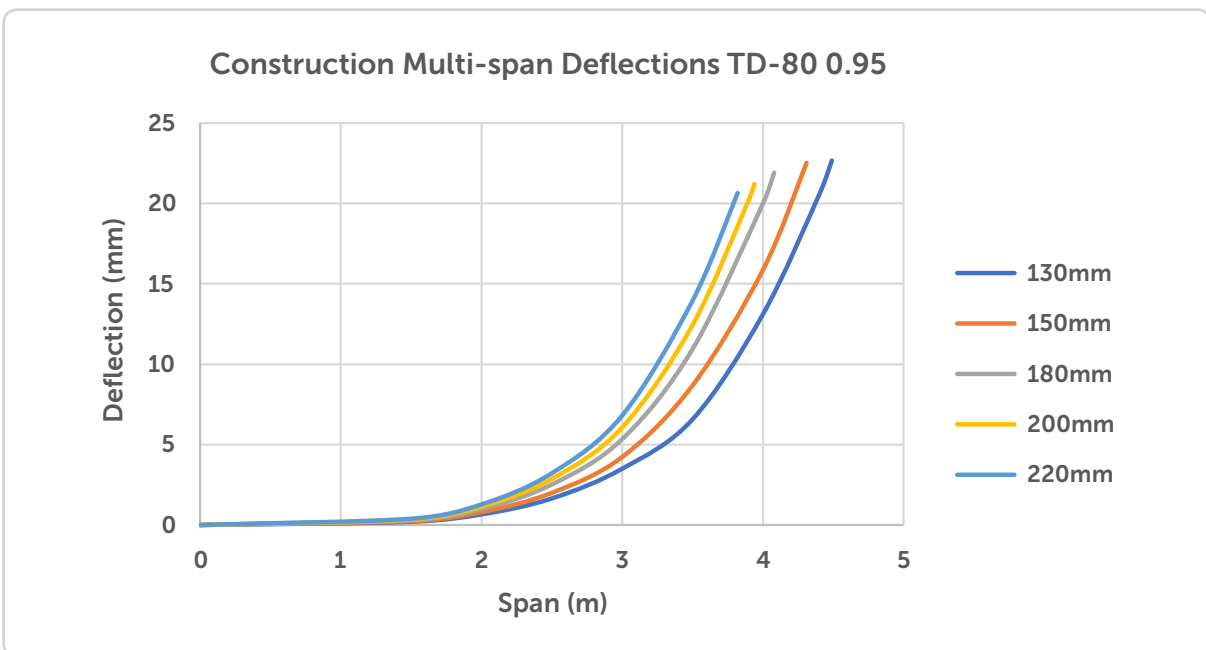

Tray-dec 80 0.95mm multi-span deflections as a function of span length for different slab depths



# Tray-dec 80: $t = 0.95$

## SPAN TABLES

**NOTES:** Where ← is shown, construction stage span governs. All span tables have been made using a 150mm support width. All spans are in metres.

### Single span, no temporary prop

Slab Depth (mm)	Construction Stage	Composite Stage – Imposed Load				
		1.5 kPa	2.0 kPa	3.0 kPa	5.0 kPa	10.0 kPa
130	4.2	←	←	←	3.9	3.3
140	4.1	←	←	←	←	3.5
150	4.0	←	←	←	←	3.7
160	3.9	←	←	←	←	←
180	3.7	←	←	←	←	←
200	3.6	←	←	←	←	←
220	3.5	←	←	←	←	←

### Multi-span, no temporary prop

Slab Depth (mm)	Construction Stage	Composite Stage – Imposed Load				
		1.5 kPa	2.0 kPa	3.0 kPa	5.0 kPa	10.0 kPa
130	4.5	←	←	4.3	3.9	3.3
140	4.4	←	←	←	4.1	3.5
150	4.3	←	←	←	←	3.7
160	4.2	←	←	←	←	3.9
180	4.1	←	←	←	←	←
200	3.9	←	←	←	←	←
220	3.8	←	←	←	←	←

### Propped spans (single/multi), one prop

Slab Depth (mm)	Construction Stage	Composite Stage – Imposed Load				
		1.5 kPa	2.0 kPa	3.0 kPa	5.0 kPa	10.0 kPa
130	–	4.7	4.6	4.3	3.9	3.3
140	–	4.9	4.8	4.5	4.1	3.5
150	–	5.1	4.9	4.7	4.3	3.6
160	–	5.3	5.1	4.9	4.5	3.9
180	–	5.7	5.5	5.3	4.9	4.3
200	–	6.1	5.9	5.7	5.3	4.7
220	–	6.5	6.3	6.1	5.7	5.1



# Tray-dec 80: $t = 1.2$

## CONSTRUCTION DEFLECTION GRAPHS

**NOTE:** Span values are from centreline to centreline of supports based on a beam flange width of 150mm.

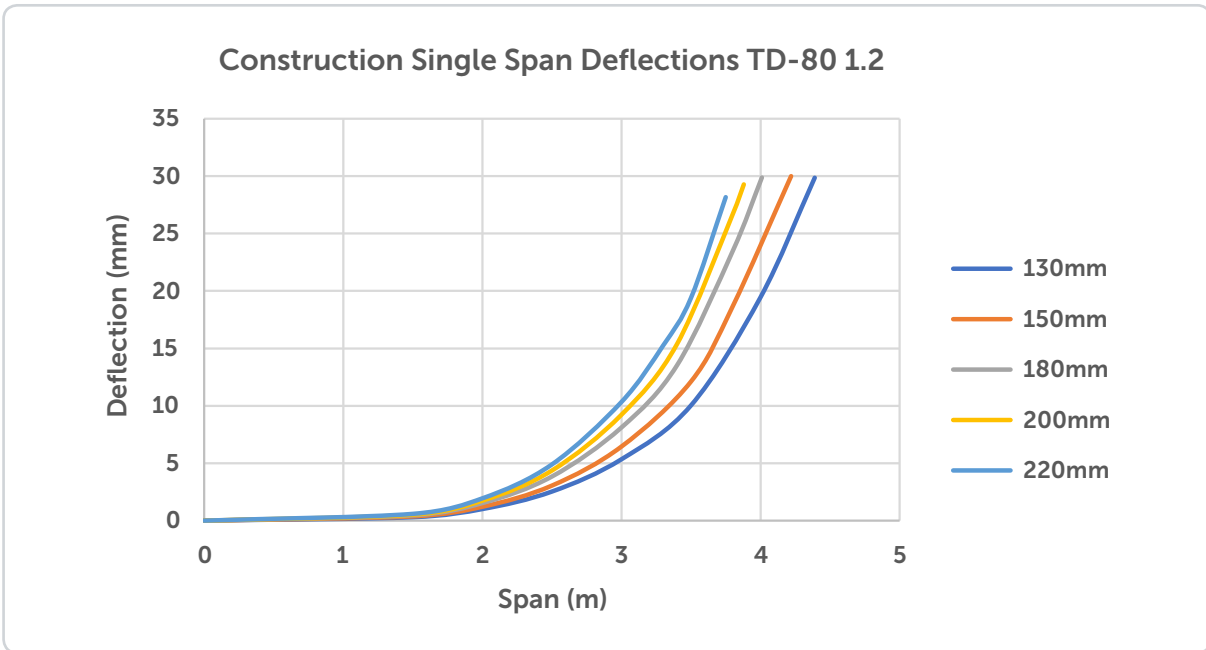

Tray-dec 80 1.2mm single span deflections as a function of span length for different slab depths

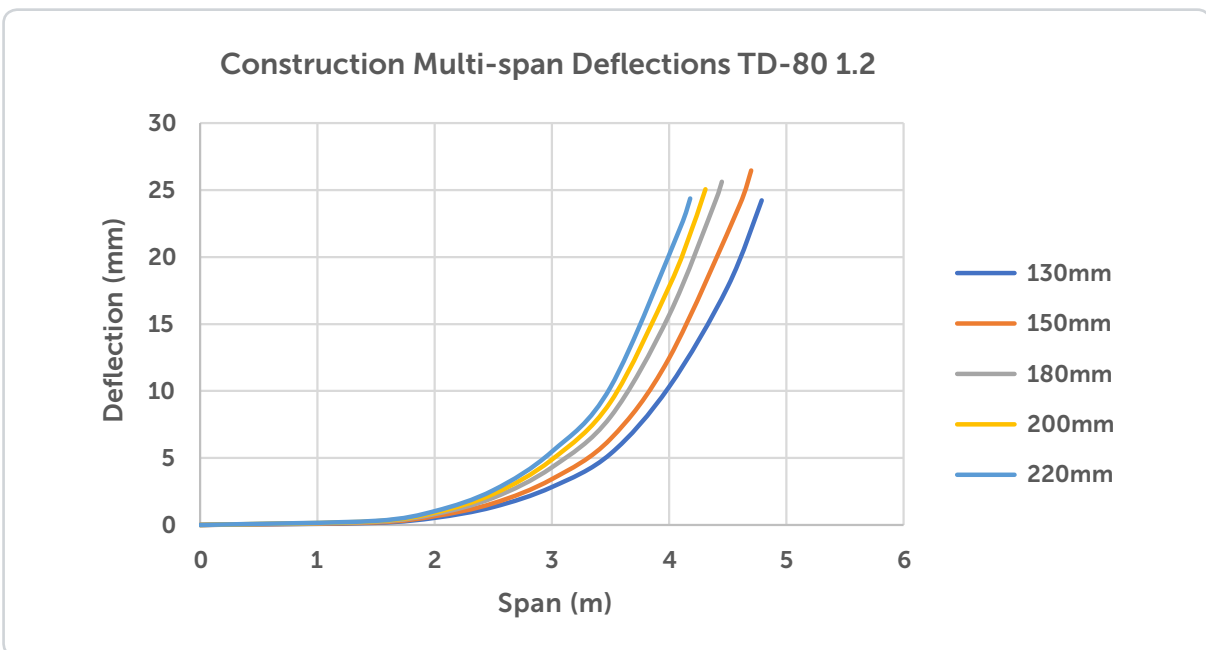

Tray-dec 80 1.2mm multi-span deflections as a function of span length for different slab depths



# Tray-dec 80: $t = 1.2$

## SPAN TABLES

**NOTES:** Where ← is shown, construction stage span governs. All span tables have been made using a 150mm support width. All spans are in metres.

### Single span, no temporary prop

Slab Depth (mm)	Construction Stage	Composite Stage – Imposed Load				
		1.5 kPa	2.0 kPa	3.0 kPa	5.0 kPa	10.0 kPa
130	4.5	←	←	4.3	4.0	3.3
140	4.4	←	←	←	4.1	3.5
150	4.3	←	←	←	←	3.7
160	4.2	←	←	←	←	3.9
180	4.0	←	←	←	←	←
200	3.9	←	←	←	←	←
220	3.7	←	←	←	←	←

### Multi-span, no temporary prop

Slab Depth (mm)	Construction Stage	Composite Stage – Imposed Load				
		1.5 kPa	2.0 kPa	3.0 kPa	5.0 kPa	10.0 kPa
130	–	4.7	4.6	4.3	3.9	3.3
140	4.8	←	←	4.5	4.1	3.5
150	4.7	←	←	←	4.3	3.7
160	4.6	←	←	←	4.5	3.9
180	4.4	←	←	←	←	←
200	4.3	←	←	←	←	←
220	4.2	←	←	←	←	←

### Propped spans (single/multi), one prop

Slab Depth (mm)	Construction Stage	Composite Stage – Imposed Load				
		1.5 kPa	2.0 kPa	3.0 kPa	5.0 kPa	10.0 kPa
130	–	4.7	4.6	4.3	3.9	3.3
140	–	4.9	4.8	4.5	4.1	3.5
150	–	5.1	5.0	4.7	4.3	3.7
160	–	5.3	5.2	4.9	4.6	3.9
180	–	5.8	5.6	5.4	5.0	4.4
200	–	6.2	6.1	5.8	5.4	4.8
220	–	6.6	6.5	6.2	5.9	5.2





**Top right:**

*Pokeno Substation – Pokeno, Waikato*

**Bottom right:**

*Harington Street Carpark – Tauranga, Bay of Plenty*

**Below:**

*Tray-dec installer cutting materials to site specific dimensions*

**Bottom left:**

*TK Meat Factory – Te Kuiti, Waikato*

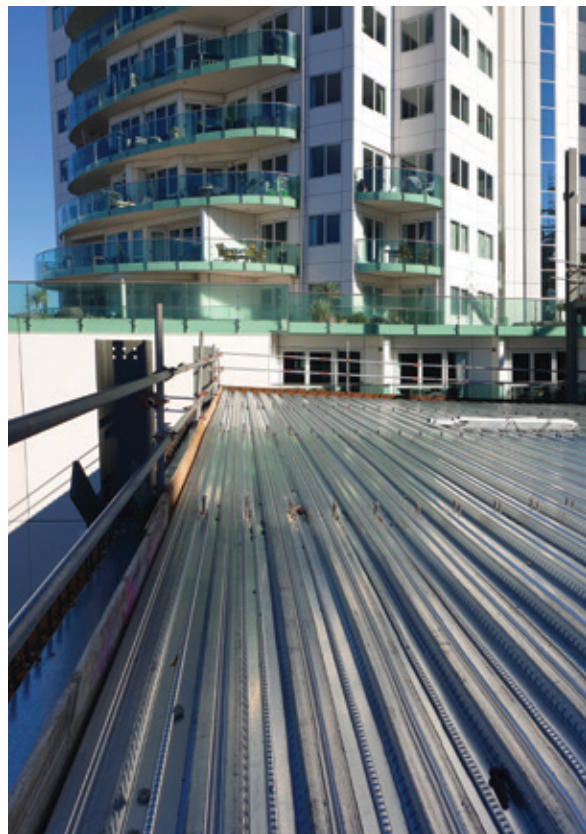
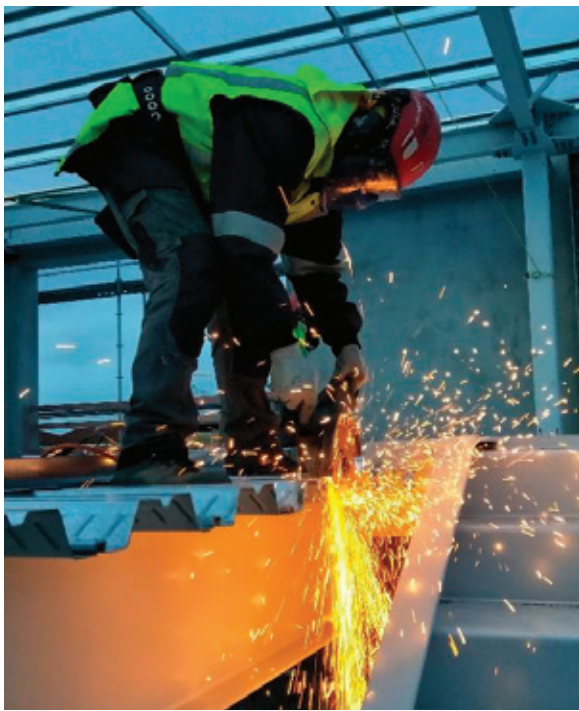



# Tray-dec 60



**Tray-dec 60** is an intermediate decking solution with mid-range spanning capabilities. It is lighter and a lower cost than larger profiled composite decking. The minimum slab thickness for Tray-dec 60 is 110mm.

## Design

Adjacent sheets are joined along the overlapping edge using self-tapping screws. The inverted (rather than re-entrant) top rib maximises concrete cover for a given slab thickness and increases strength in composite action.

## Nelson Shear Stud Placement

Symmetrical interlocking trays allow for simple and even placement of Nelson shear studs. Studs welded through deck optimise composite properties of the slab.

*Below: HS3 Building – Hamilton, Waikato using Tray-dec 60*

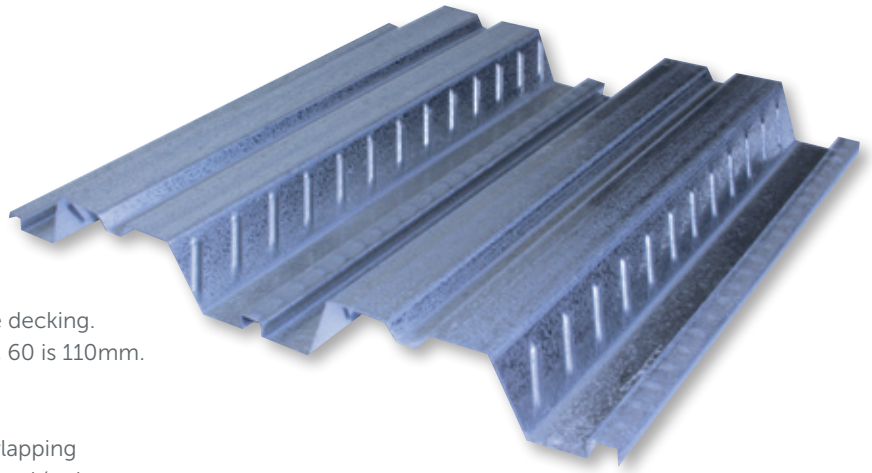

## Quality Materials

All Tray-dec 60 is rolled from high strength zinc-coated steel coil in compliance with AS 1397-2011. Tray-dec 60 profiles are made from grade G500 steel and are available in either 0.75mm or 0.95mm thickness. Construction and composite span tables are provided for each grade.

## Accessories

Accessories to complete necessary formwork include internal and external end caps, folded metal edge form to suit the slab thickness and closure plates.





# Tray-dec 60

## TRAY-DEC 60 CAD DRAWING

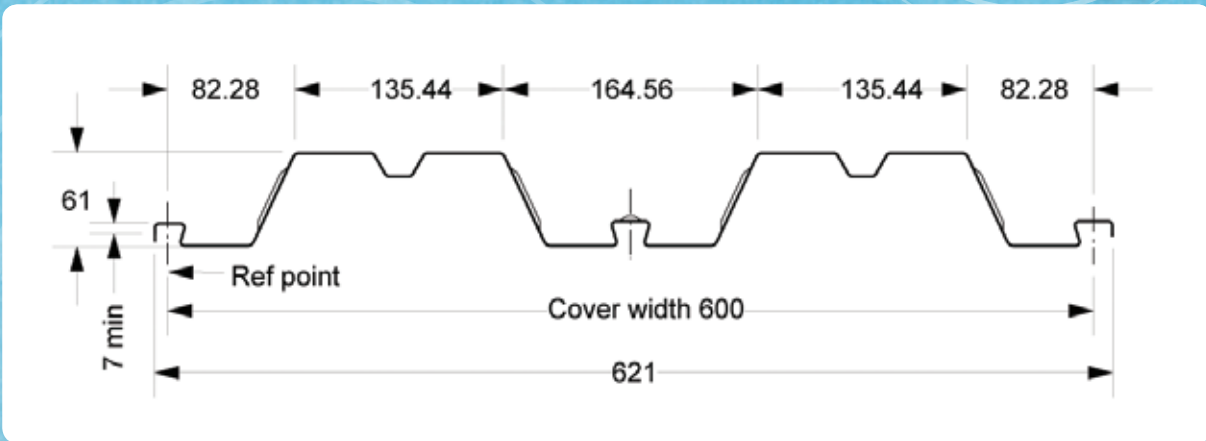
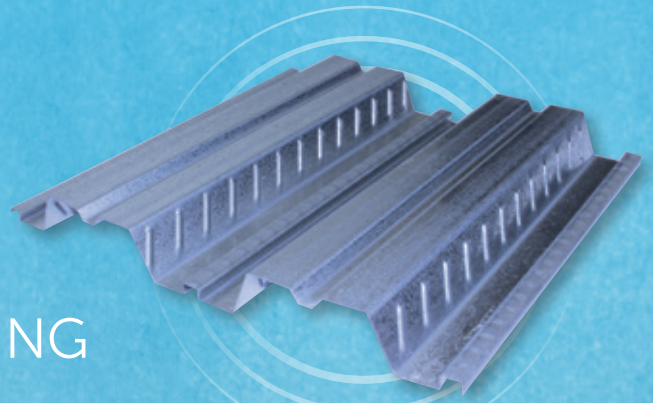

### Tray-dec 60 - Section Properties (per metre width)

Section Thickness (mm)	Design Mass (kg/m <sup>2</sup> )	Profile Weight (kN/m <sup>2</sup> )	Cross Section Area (mm <sup>2</sup> /m)	Height to Neutral Axis (mm)	Moment of Inertia (cm <sup>4</sup> /m)	Ultimate Moment Capacity (kNm/m)
0.75	8.59	0.084	1104.48	30.14	63.176	11.258
0.95	10.88	0.107	1399.51	30.35	80.023	13.482

### Tray-dec 60

#### Volume & Weight of Concrete (kN/m<sup>2</sup>) Table 2

Slab Depth (mm)	Volume (m <sup>3</sup> /m <sup>2</sup> )	Normal Weight Wet	Concrete Dry
110	0.078	1.87	1.83
120	0.088	2.11	2.07
130	0.098	2.35	2.30
140	0.108	2.59	2.54
150	0.118	2.83	2.77
160	0.128	3.07	3.01
170	0.138	3.31	3.25
180	0.148	3.55	3.48
190	0.158	3.79	3.72
200	0.168	4.03	3.95

#### TABLE ASSUMES THE FOLLOWING:

1. The weight of concrete is 2400kg/m<sup>3</sup> (wet) and 2350kg/m<sup>3</sup> (dry).
2. Weight of deck, mesh and reinforcing is not included.
3. No ponding has been allowed.





*Cochrane Accountants  
Building – Palmerston North,  
Manawatu-Wanganui  
using Tray-dec 60*

# Tray-dec 60: $t = 0.75$

## CONSTRUCTION DEFLECTION GRAPHS

**NOTE:** Span values are from centreline to centreline of supports based on a beam flange width of 150mm.

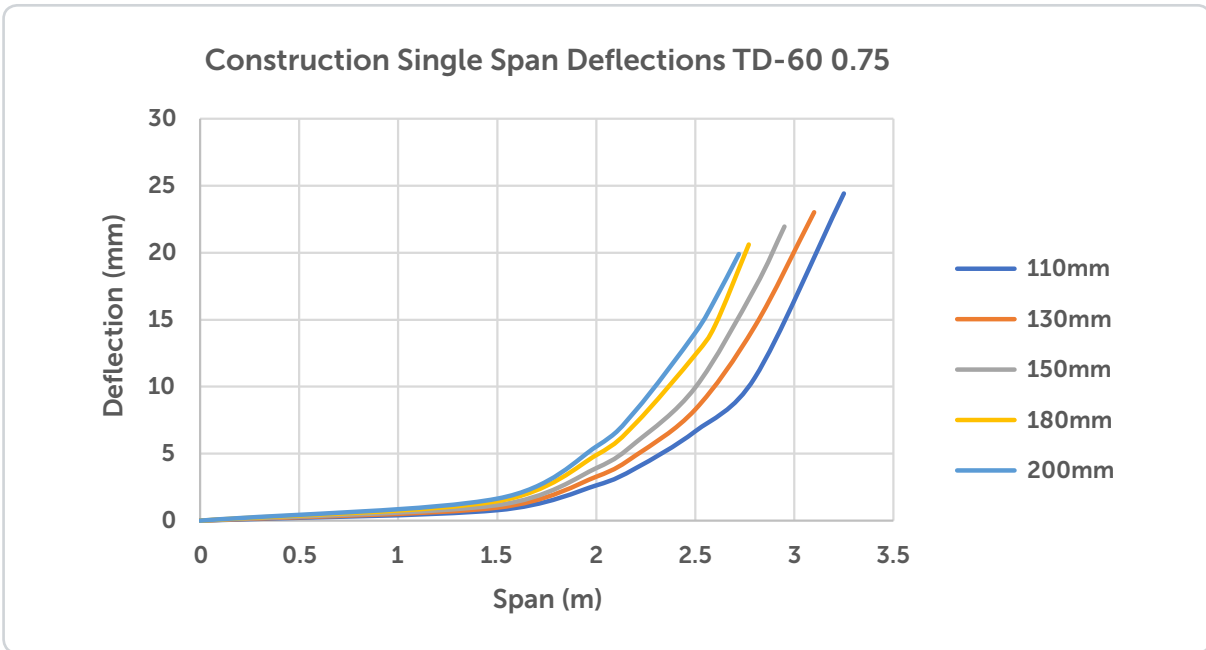

Tray-dec 60 0.75mm single span deflections as a function of span for different slab depths

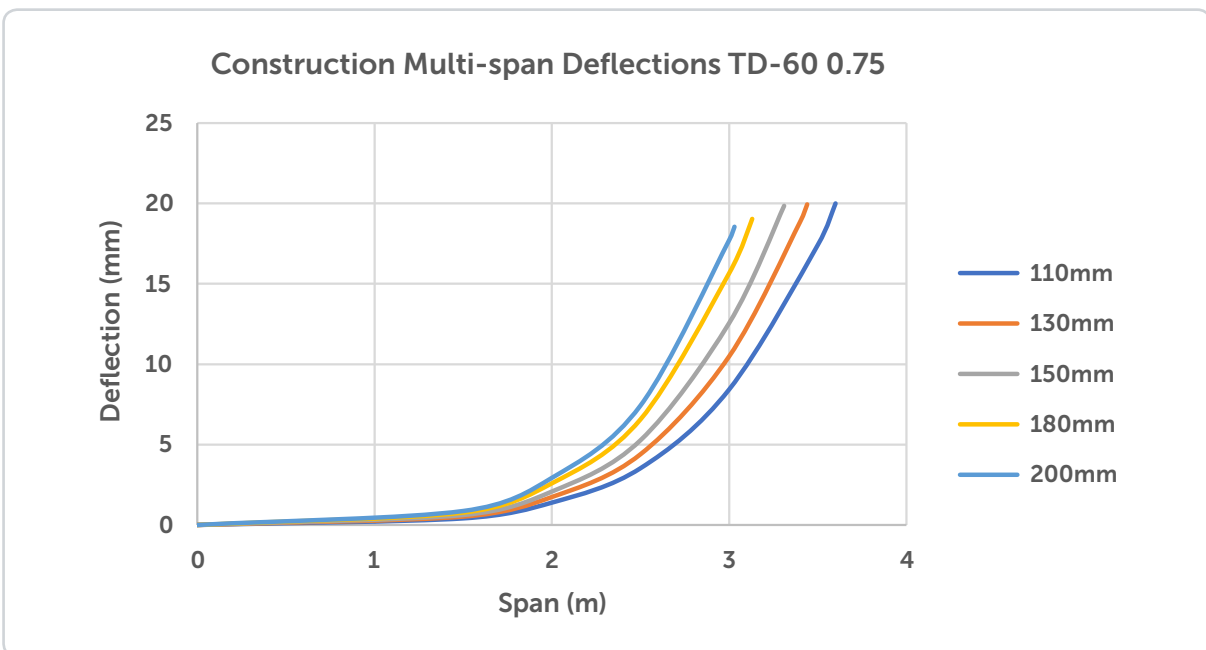

Tray-dec 60 0.75mm multi-span deflections as a function of span for different slab depths



# Tray-dec 60: $t = 0.75$

## SPAN TABLES

**NOTES:** Where ← is shown, construction stage span governs. All span tables have been made using a 150mm support width. All spans are in metres.

### Single span, no temporary prop

Slab Depth (mm)	Construction Stage	Composite Stage – Imposed Load				
		1.5 kPa	2.0 kPa	3.0 kPa	5.0 kPa	10.0 kPa
110	3.3	←	←	←	←	2.8
120	3.2	←	←	←	←	3.0
130	3.1	←	←	←	←	←
140	3.0	←	←	←	←	←
150	2.9	←	←	←	←	←
180	2.8	←	←	←	←	←
200	2.7	←	←	←	←	←

### Multi-span, no temporary prop

Slab Depth (mm)	Construction Stage	Composite Stage – Imposed Load				
		1.5 kPa	2.0 kPa	3.0 kPa	5.0 kPa	10.0 kPa
110	3.6	←	←	←	3.3	2.8
120	3.5	←	←	←	←	3.0
130	3.4	←	←	←	←	3.2
140	3.4	←	←	←	←	←
150	3.3	←	←	←	←	←
180	3.1	←	←	←	←	←
200	3.0	←	←	←	←	←

### Propped spans (single/multi), one prop

Slab Depth (mm)	Construction Stage	Composite Stage – Imposed Load				
		1.5 kPa	2.0 kPa	3.0 kPa	5.0 kPa	10.0 kPa
110	–	4.1	3.9	3.7	3.3	2.8
120	–	4.3	4.2	3.9	3.5	3.0
130	–	4.4	4.3	4.1	3.7	3.2
140	–	4.6	4.5	4.3	3.9	3.4
150	–	4.8	4.7	4.5	4.1	3.6
180	–	5.5	5.4	5.2	4.8	4.2
200	5.6	←	←	←	5.2	4.6

# Tray-dec 60: $t = 0.95$

## CONSTRUCTION DEFLECTION GRAPHS

**NOTE:** Span values are from centreline to centreline of supports based on a beam flange width of 150mm.

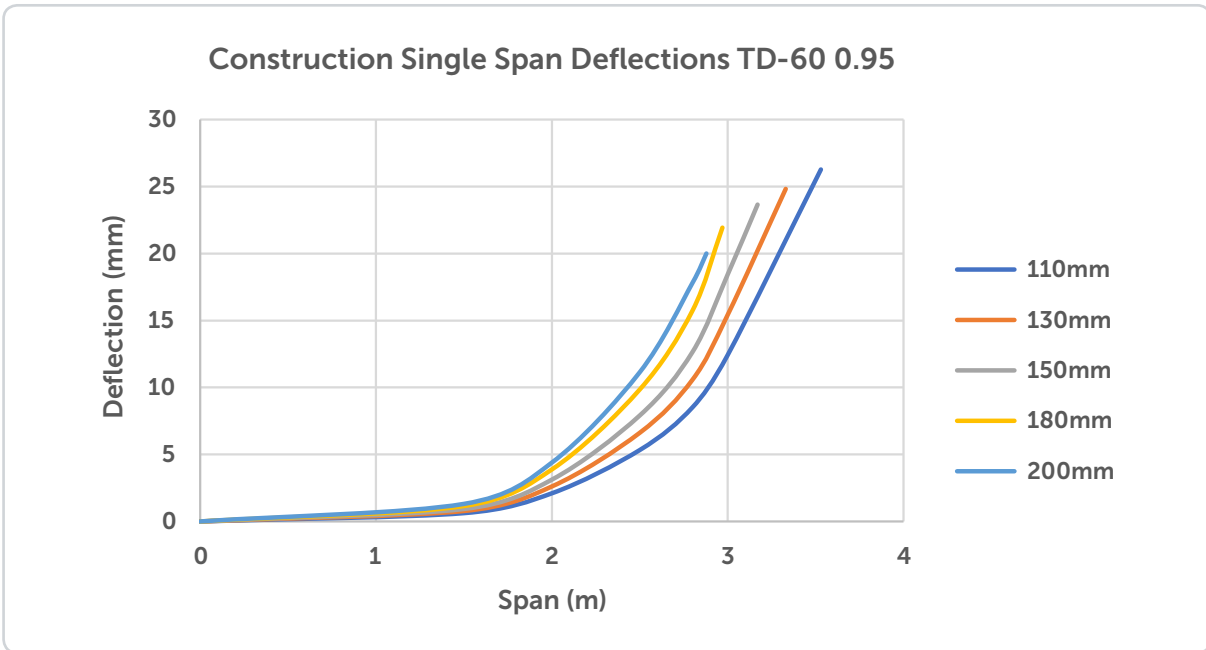

Tray-dec 60 0.95mm single span deflections as a function of span for different slab depths

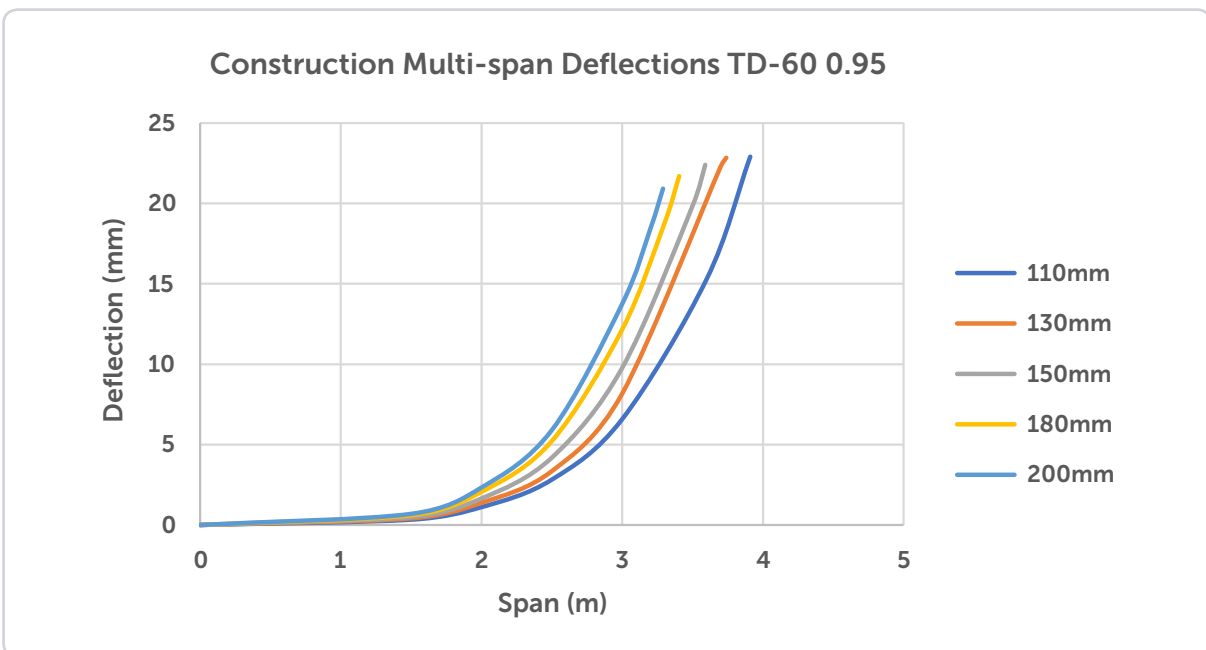

Tray-dec 60 0.95mm multi-span deflections as a function of span for different slab depths



# Tray-dec 60: $t = 0.95$

## SPAN TABLES

**NOTES:** Where ← is shown, construction stage span governs. All span tables have been made using a 150mm support width. All spans are in metres.

### Single span, no temporary prop

Slab Depth (mm)	Construction Stage	Composite Stage – Imposed Load				
		1.5 kPa	2.0 kPa	3.0 kPa	5.0 kPa	10.0 kPa
110	3.5	←	←	←	3.4	2.8
120	3.4	←	←	←	←	3.0
130	3.3	←	←	←	←	3.2
140	3.2	←	←	←	←	←
150	3.2	←	←	←	←	←
180	3.0	←	←	←	←	←
200	2.9	←	←	←	←	←

### Multi-span, no temporary prop

Slab Depth (mm)	Construction Stage	Composite Stage – Imposed Load				
		1.5 kPa	2.0 kPa	3.0 kPa	5.0 kPa	10.0 kPa
110	3.9	←	←	3.7	3.4	2.8
120	3.8	←	←	←	3.6	3.0
130	3.7	←	←	←	←	3.2
140	3.7	←	←	←	←	3.4
150	3.6	←	←	←	←	←
180	3.4	←	←	←	←	←
200	3.3	←	←	←	←	←

### Propped spans (single/multi), one prop

Slab Depth (mm)	Construction Stage	Composite Stage – Imposed Load				
		1.5 kPa	2.0 kPa	3.0 kPa	5.0 kPa	10.0 kPa
110	–	4.1	4.0	3.7	3.4	2.8
120	–	4.3	4.2	3.9	3.6	3.0
130	–	4.5	4.4	4.1	3.8	3.2
140	–	4.7	4.6	4.4	4.0	3.4
150	–	4.9	4.8	4.6	4.2	3.7
180	–	5.6	5.5	5.3	4.9	4.3
200	–	6.1	6.0	5.7	5.4	4.7





*Residential project –  
Mangawhai, Northland  
using Tray-dec 300*



# Tray-dec 300



**Tray-dec 300** is a flat soffit composite deck where adjacent trays interlock to act as both tensile reinforcement and permanent formwork for a complete concrete floor slab.

*Designs are in accordance with AS/NZS 2327:2017*

## Design

Tray-dec 300 has a profile with a flat soffit allowing uniform slab thickness and can be used for buildings constructed of steel, concrete or masonry. The uniform slab thickness results in optimal acoustic performance. No end closures are required, and sheets interlock without the use of fasteners, crimping, drilling or riveting.

## Nelson Shear Stud Placement

Self-locking trays spaced every 300mm makes Nelson shear stud installation convenient. Studs welded through deck optimise composite properties of the slab.

*Below: Residential project – Bucklands Beach, Auckland using Tray-dec 300*

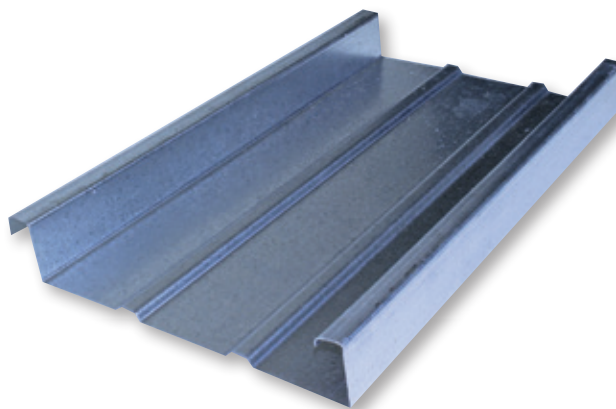

## Quality Materials

All Tray-dec 300 is rolled from high strength zinc-coated steel coil in compliance with AS 1397-2011. Tray-dec 300 profiles are made from grade G500 steel and are available in either 0.75mm or 0.95mm thickness. Construction and composite span tables are provided for each grade.

## Accessories

Because of the flat underside of the profile, Tray-dec 300 does not require end caps to prevent concrete spillage. Folded metal edge form is manufactured to suit slab thickness.





# Tray-dec 300

## TRAY-DEC 300 CAD DRAWING

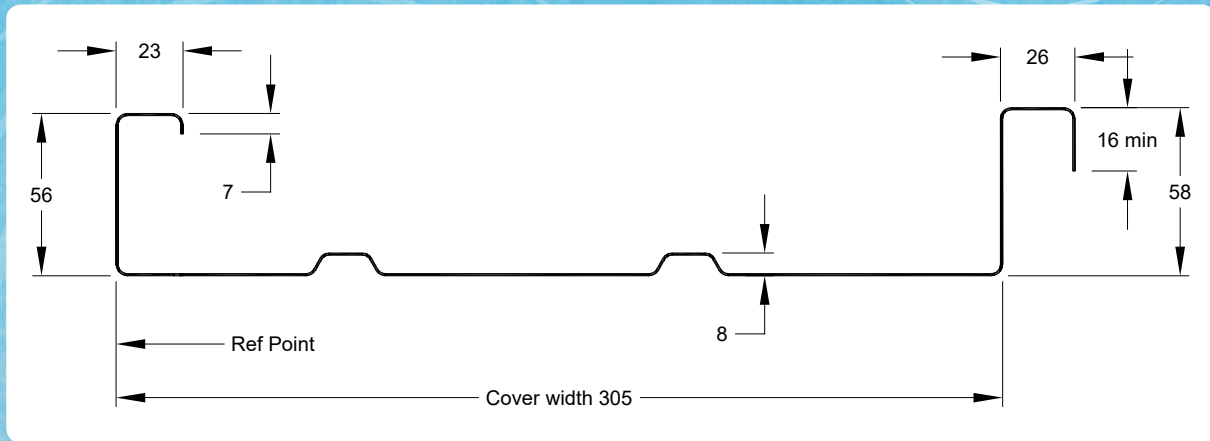
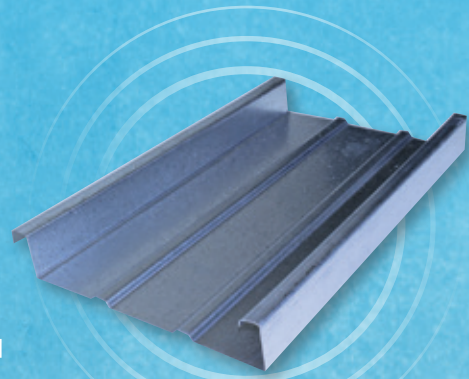

### Tray-dec 300 - Section Properties (per metre width)

Section Thickness (mm)	Design Mass (kg/m <sup>2</sup> )	Profile Weight (kN/m <sup>2</sup> )	Cross Section Area (mm <sup>2</sup> /m)	Height to Neutral Axis (mm)	Moment of Inertia (cm <sup>4</sup> /m)	Ultimate Moment Capacity (kNm/m)
0.75	9.90	0.097	1219.69	14.70	51.99	7.08
0.95	12.54	0.123	1545.74	14.81	65.96	9.19

### Tray-dec 300

#### Volume & Weight of Concrete (kN/m<sup>2</sup>) Table 3

Slab Depth (mm)	Volume (m <sup>3</sup> /m <sup>2</sup> )	Normal Weight	Concrete
		Wet	Dry
100	0.10	2.40	2.35
110	0.11	2.64	2.59
120	0.12	2.88	2.82
130	0.13	3.12	3.06
140	0.14	3.36	3.29
150	0.15	3.60	3.53
160	0.16	3.84	3.76
170	0.17	4.08	4.00
180	0.18	4.32	4.23
190	0.19	4.56	4.47
200	0.20	4.80	4.70

#### TABLE ASSUMES THE FOLLOWING:

1. The weight of concrete is 2400kg/m<sup>3</sup> (wet) and 2350kg/m<sup>3</sup> (dry).
2. Weight of deck, mesh and reinforcing is not included.
3. No ponding has been allowed.



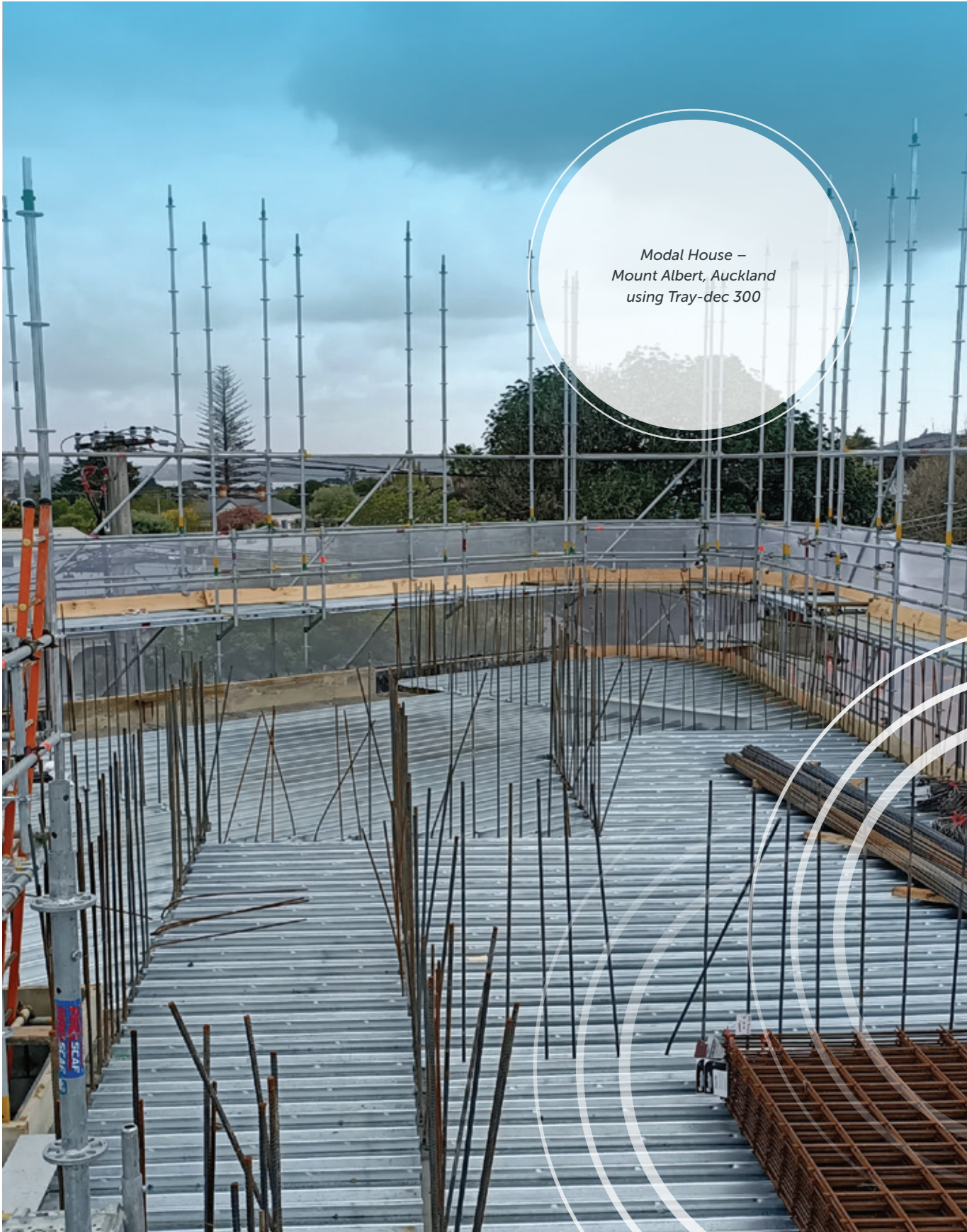

*Modal House –  
Mount Albert, Auckland  
using Tray-dec 300*

# Tray-dec 300: $t = 0.75$

## CONSTRUCTION DEFLECTION GRAPHS

**NOTE:** Span values are from centreline to centreline of supports based on a beam flange width of 150mm.

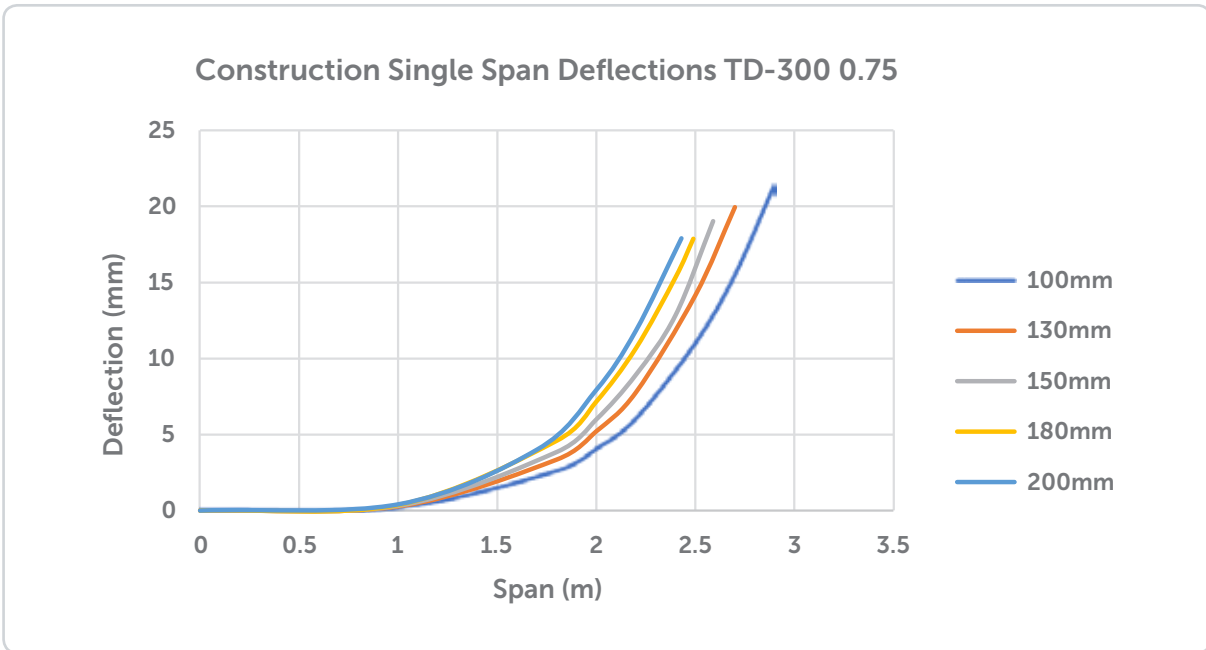

Tray-dec 300 0.75mm single span deflections as a function of span for different slab depths

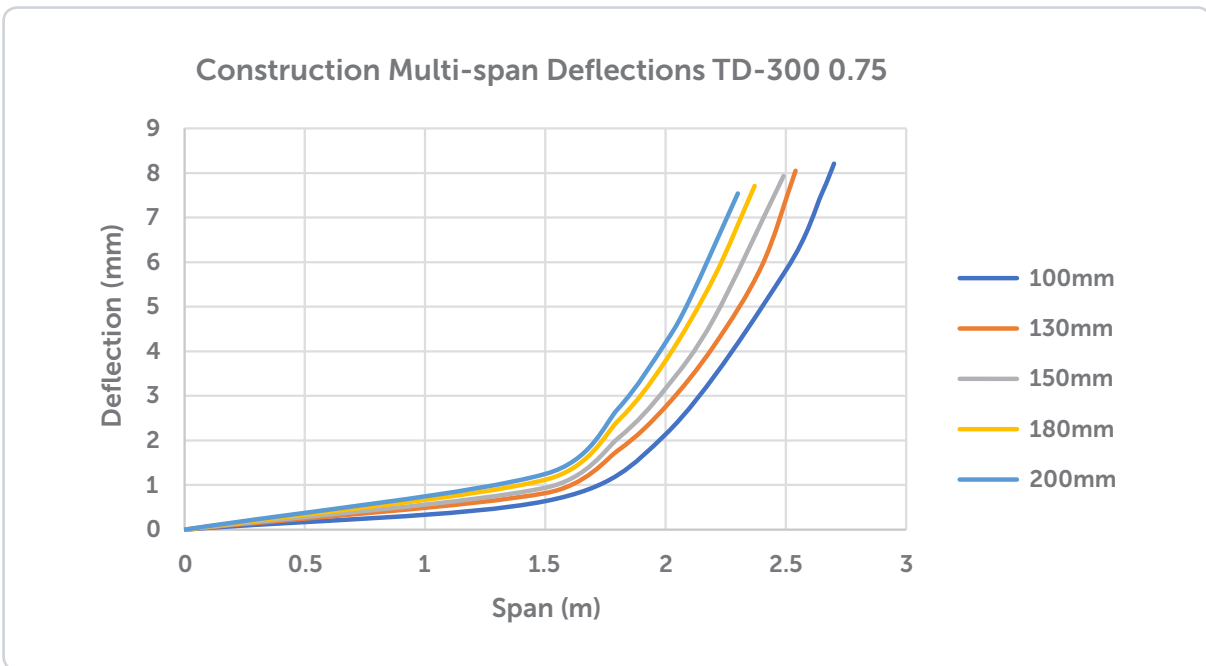

Tray-dec 300 0.75mm multi-span deflections as a function of span for different slab depths



# Tray-dec 300: $t = 0.75$

## SPAN TABLES

**NOTES:** Where ← is shown, construction stage span governs. All span tables have been made using a 150mm support width. All spans are in metres.

### Single span, no temporary prop

Slab Depth (mm)	Construction Stage	Composite Stage – Imposed Load				
		1.5 kPa	2.0 kPa	3.0 kPa	5.0 kPa	10.0 kPa
100	2.9	←	←	←	←	2.8
110	2.8	←	←	←	←	←
120	2.8	←	←	←	←	←
130	2.7	←	←	←	←	←
150	2.6	←	←	←	←	←
180	2.5	←	←	←	←	←
200	2.4	←	←	←	←	←

### Multi-span, no temporary prop

Slab Depth (mm)	Construction Stage	Composite Stage – Imposed Load				
		1.5 kPa	2.0 kPa	3.0 kPa	5.0 kPa	10.0 kPa
100	2.7	←	←	←	←	←
110	2.6	←	←	←	←	←
120	2.5	←	←	←	←	←
130	2.5	←	←	←	←	←
150	2.4	←	←	←	←	←
180	2.4	←	←	←	←	←
200	2.3	←	←	←	←	←

### Propped spans (single/multi), one prop

Slab Depth (mm)	Construction Stage	Composite Stage – Imposed Load				
		1.5 kPa	2.0 kPa	3.0 kPa	5.0 kPa	10.0 kPa
100	–	3.9	3.8	3.6	3.3	2.8
110	–	4.2	4.1	3.9	3.6	2.9
120	–	4.5	4.4	4.1	3.8	3.3
130	4.7 / 4.8	4.7	4.6	4.4	4.1	3.5
150	4.6 / 4.9	←	←	←	4.5	4.0
180	4.3 / 4.6	←	←	←	←	←
200	4.2 / 4.5	←	←	←	←	←

# Tray-dec 300: $t = 0.95$

## CONSTRUCTION DEFLECTION GRAPHS

**NOTE:** Span values are from centreline to centreline of supports based on a beam flange width of 150mm.

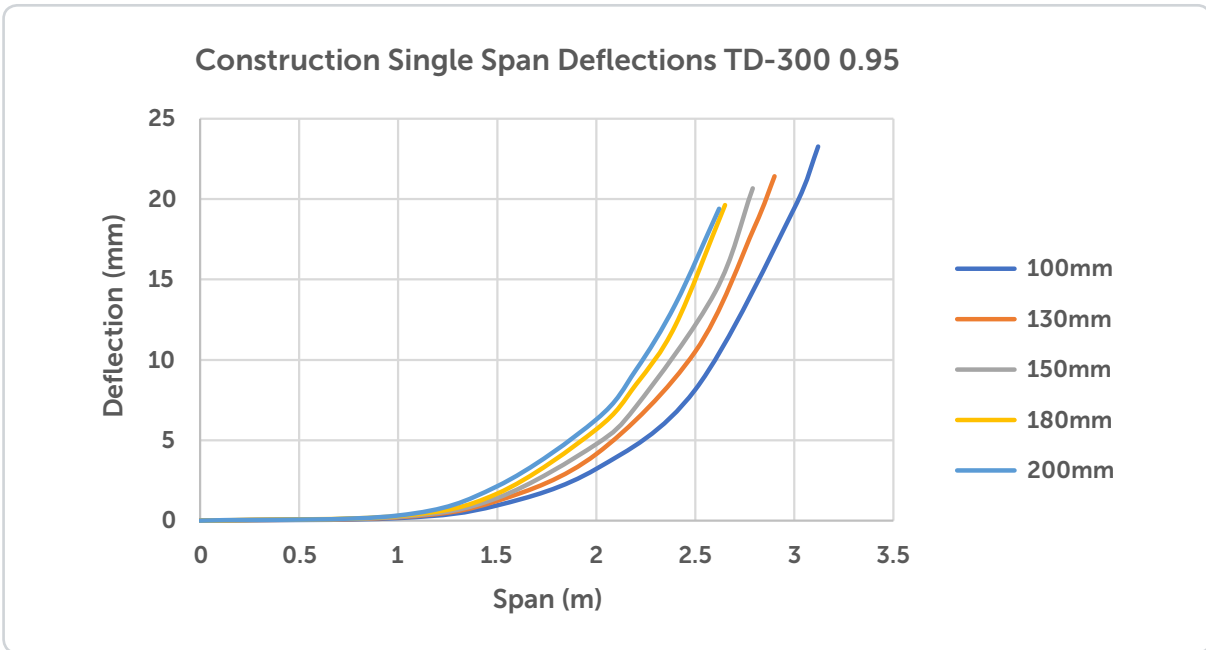

Tray-dec 300 0.95mm single span deflections as a function of span for different slab depths

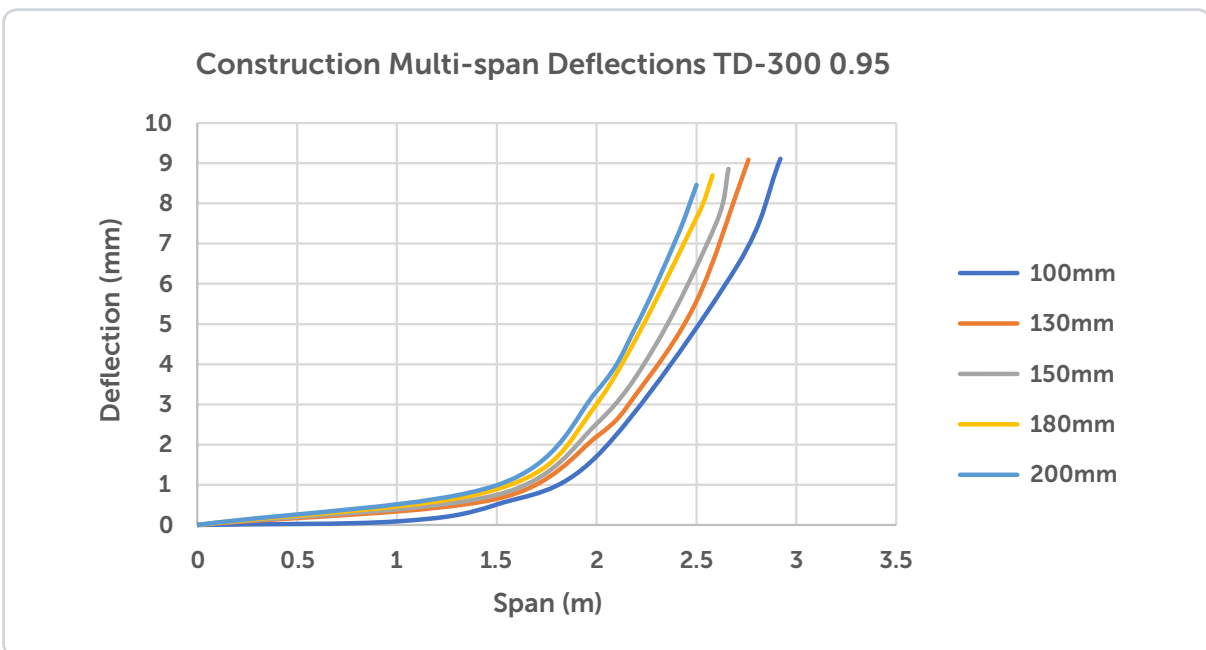

Tray-dec 300 0.95mm multi-span deflections as a function of span for different slab depths



# Tray-dec 300: $t = 0.95$

## SPAN TABLES

**NOTES:** Where ← is shown, construction stage span governs. All span tables have been made using a 150mm support width. All spans are in metres.

### Single span, no temporary prop

Slab Depth (mm)	Construction Stage	Composite Stage – Imposed Load				
		1.5 kPa	2.0 kPa	3.0 kPa	5.0 kPa	10.0 kPa
100	3.1	←	←	←	←	2.8
110	3.0	←	←	←	←	←
120	3.0	←	←	←	←	←
130	2.9	←	←	←	←	←
150	2.8	←	←	←	←	←
180	2.6	←	←	←	←	←
200	2.6	←	←	←	←	←

### Multi-span, no temporary prop

Slab Depth (mm)	Construction Stage	Composite Stage – Imposed Load				
		1.5 kPa	2.0 kPa	3.0 kPa	5.0 kPa	10.0 kPa
100	2.9	←	←	←	←	←
110	2.9	←	←	←	←	←
120	2.8	←	←	←	←	←
130	2.8	←	←	←	←	←
150	2.7	←	←	←	←	←
180	2.6	←	←	←	←	←
200	2.5	←	←	←	←	←

### Propped spans (single/multi), one prop

Slab Depth (mm)	Construction Stage	Composite Stage – Imposed Load				
		1.5 kPa	2.0 kPa	3.0 kPa	5.0 kPa	10.0 kPa
100	–	3.9	3.8	3.6	3.3	2.8
110	–	4.2	4.1	3.9	3.6	3.1
120	–	4.5	4.4	4.2	3.8	3.3
130	–	4.8	4.6	4.4	4.1	3.5
150	5.0 / 5.3	←	←	←	4.6	4.0
180	4.7 / 5.1	←	←	←	←	4.7
200	4.6 / 4.9	←	←	←	←	←

# NZ Building Code Compliance

If the Tray-dec flooring system is designed, used, installed and maintained in accordance with the guidelines of the product guide, Tray-dec flooring systems can reasonably be expected to meet the performance criteria in clause B1 structure, B2 durability and C fire of the New Zealand Building Code for a period of not less than 50 years, provided they are kept free of moisture. Sound G6 and vibration are also part of the NZBC and are considered in the Tray-dec design calculations.

## Coating & Material Specification

Tray-dec flooring is manufactured from galvanised coil with 275g/m<sup>2</sup> total zinc coating weight. The design yield strengths that have been used are as follows:

- 550 MPa for 0.75mm BMT
- 520 MPa for 0.95mm BMT
- 500 MPa for 1.20mm BMT

## Structure B1

The Tray-dec flooring system has been designed to comply with AS/NZS 2327:2017 using the relevant load and clause combinations of the New Zealand Building Code. Detailed analysis and physical testing have enabled load/span tables to be established

based on the limits imposed by the relevant standards and design philosophy.

Use of Tray-dec flooring system in applications other than uniformly distributed loads or outside the scope of this document will require specific design. Data presented in this document and derived from our software is intended for use by structural engineers.

## Durability B2

The use of Tray-dec flooring systems is limited to dry and non-corrosive environments. It is the responsibility of the designer to assess the durability requirements of the flooring slab. Consideration must be given to minimum concrete cover of the reinforcement. NZS 3101 provides guidance in this area.

When using Tray-dec flooring systems in other areas, achieving the required durability of the system is dependent on addressing the following:

1. For protection of the galvanised underside surface, an application of a suitable paint system may be required due to the location.



Harington Street Carpark – Tauranga, Bay of Plenty using Tray-dec 80



2. Where the top surface requires protection to prevent the ingress of moisture entering the concrete one of the following methods is required:
  - a. Design reinforcement in the slab for "Strong Crack Control". See *HERA Report R4-113 Section 3.3 Control of Cracking and Leaks*.
  - b. Application of a suitable proprietary waterproofing agent either mixed into the concrete before pouring or sprayed onto the top surface after curing, with the minimum necessary reinforcement in the slab.
  - c. Application of a proprietary waterproof membrane with the minimum necessary reinforcement in the slab.

### C. Protection from Fire

Fire design for providing any fire rating is carried out in accordance to NZS 3101:2006 and AS/NZS 2327:2017, Section 7. Minimum concrete thickness must be in accordance with NZS 2327:2017 Table 7.7.2.2 for the fire insulation requirements only.

### Additional Protection Requirements

Unless an appropriate protective coating system is applied to the underside surface and fully maintained for the design life of the structure, the use of galvanised

sheets should be avoided where the following situations exist: high concentrations of chemicals; humidity; marine salts; timber treatment salts; and unventilated sub floor areas. Chemical admixtures may only be used in the topping concrete if they are compatible with galvanised steel. The top surface galvanised coating may need additional protection by control of topping concrete crack widths or other measures when the top of the slab is exposed to a corrosive environment.

### Sound G6

The approved NZBC document for sound is "Airborne & Impact Sound G6". Design for sound reduction requires consideration of floor finishes, ceiling details and insulation. Refer to the complete acoustic report for each profile on our website.

### Vibration

A primary vibration check is calculated in accordance with ES ISO 10137:2012, as recommended by NZS 2327:2017 Clause 6.4.1. A critical damping ratio is assumed as 3.0%. The vibration analysis is recommended to be checked by the designer case by case.



# Nelson Shear Studs and Tray-dec

Nelson shear studs are used in composite construction to secure concrete to steel structural components. They are essential in transferring force between the steel beams and the concrete slab. The shear studs may either be welded directly to the beam or through the Tray-dec.

Tray-dec floors have been designed to maximise strength in the flooring system as well as to accommodate for Nelson shear stud installation. To view physical properties of shear studs used with

Tray-dec floors, please refer to the appropriate tables in the Appendices. These tables include shear capacity and tension capacity in concrete. Tray-dec 60 and Tray-dec 80 are both symmetrical interlocking trays allowing for single or double Nelson shear studs to be installed every 300mm. Tray-dec 300 also allows Nelson shear stud installation at the same spacing.

For technical information on the physical properties of Nelson shear studs and their tension capacity please refer to information in the Appendices.

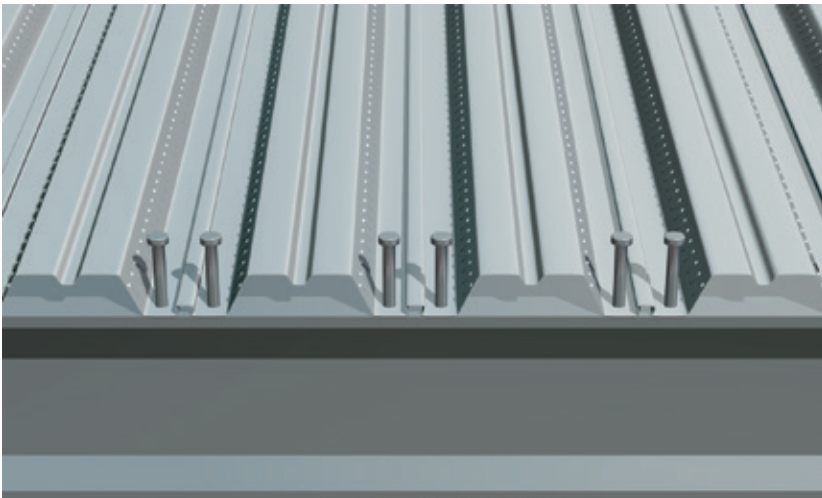

*Nelson shear studs can be welded on either side of the centre rib depending on the position of the sheet with respect to the support beam. Refer to NZS 3404.1&2:1997 A2.*

*The rib in the center of Tray-dec sheets makes installing double studs easy on smaller beams. Nelson shear studs can be installed diagonally or in a straight line on either side of the center rib when double studs are required.*







# Appendix





# Appendix

- 1 References
- 2 Branz Appraisal
- 3 Tray-dec Accessories
- 4 Maintenance Schedule of Tray-dec Floors
- 5 Builders' Guide Information / Concrete Placement
- 6 Construction Details
- 7 Acoustics Report
- 8 Nelson Shear Stud Properties







# References

## Tray-dec Systems

**AS/NZS 2327:2017** –

Composite steel-concrete in buildings. Proper use and placement of Tray-dec profiles in construction and composite stages.

## Concrete

**NZS 3101.1&2:2006** –

Concrete structures.

**NZS 3109:1997** –

Concrete construction.

## Masonry

**NZS 4230:2004** –

Design of reinforced concrete masonry structures.

## Steel

**NZS 3404 Parts 1 & 2:1997** –

Steel structures standard.

**NZS 4600:2005** –

Cold-formed steel structures.

## Reinforcement

**AS/NZS 2327:2017** –

Composite steel-concrete in buildings.

**NZS 3101:2006** –

Concrete structures.

## Fire

**AS/NZS 2327:2017** –

Composite steel-concrete in buildings.

**BS5950-8:2003** –

Structural use of steelwork in buildings.

Code of practice for fire resistant design.

**NZS/BS 476-20:1987** –

Fire tests on building materials and structures. Method for determination of the fire resistance of elements of construction (general principles).

**SCI Publications 056** –

The Fire Resistance of Composite Floors with Steel Decking (2nd Edition).

## Vibration

**AS/NZS 2327:2017** –

Composite steel-concrete in buildings.

**ISO 10137:2007** –

Bases for design of structures – serviceability of buildings and walkways against vibrations.

**SCI Publication P354** –

Design of Floors for Vibration: A new Approach.





# BRANZ Appraisal

The Tray-dec flooring system and design software has been appraised by BRANZ.

The BRANZ appraisal No. is 841 [2019]. A copy of the appraisal is available on both the Tray-dec and BRANZ websites.







# Tray-dec Accessories

## End Caps

End caps are used on Tray-dec 60 and 80 profiles to prevent leakage of concrete at the end of each Tray-dec sheet. The caps are self supporting and can be attached to the outer edge of Tray-dec sheets with self tapping screws. We provide two types of endcaps:

- External end caps – Most commonly used and easiest to install;
- Internal end caps – Used when full thickness concrete is required around the ends of the Tray-dec sheets.

## Edge Forms

Edge forms or edge flashings are made to form the perimeter of the designed concrete slab. They are customised for the specific design based on the

following criteria:

- Height – to suit the slab depth;
- Base width – determined by location of the slab edge whether it is flush to the edge of the outside beam or if there is a cantilever. If the edge form is part of a cantilever, then the fastening and the structural strength of the edge form needs to be considered.

## Restraint Straps

Restraint straps are used to connect the edge form to the steel deck to prevent the edge form from bending outward. The length and formed angle on the restraint strap is dependent on the depth of the slab and the position of the steel deck. The restraint straps are normally spaced at 600mm centres. Restraint straps are attached to the edge forms and steel deck with self-tapping screws.

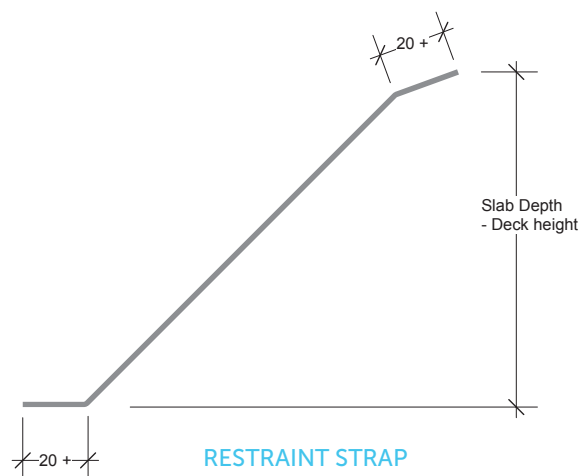
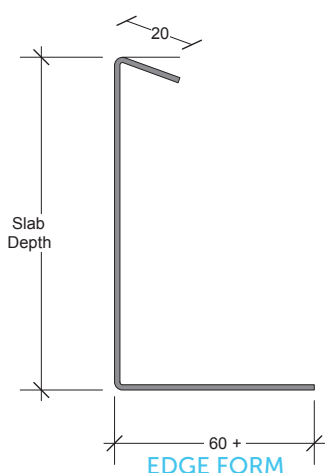

Supplied flat (bend on site to suit )

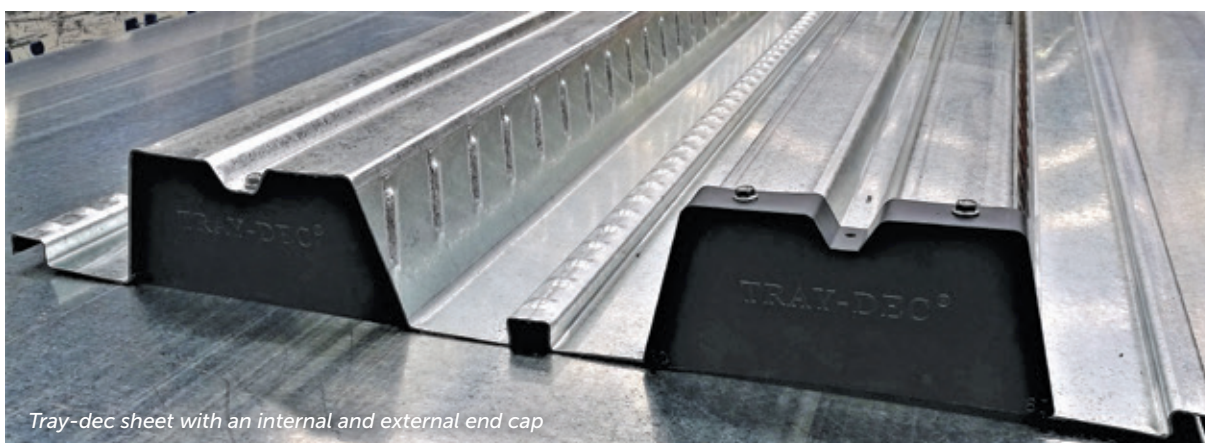

Tray-dec sheet with an internal and external end cap



# Maintenance Schedule for Tray-dec Floors

Where exposed to the elements, galvanised metal decking used for composite flooring systems should be washed regularly to avoid early consumption of the metallic coating.

It is recommended that the exposed area of metal floor is washed using high pressure water blasting every six months. Visual inspection should be carried out every year and if any corrosion is detected this should immediately be repaired.

Where galvanised metal decking is used for composite flooring systems on internal floors, the metal decking

should be inspected annually as part of the routine building maintenance programme.

Where any damage to the metal coating is detected this should be immediately painted to prevent corrosion of the base metal. We recommend using Resene Armourcote 510 High Solids Epoxy for treatment of the deck (refer to the Tray-dec website).

Refer to BlueScope Steel durability statement Rev 4, February 2004 for further information (refer to the Tray-dec website). Where the underside is not exposed then no maintenance should be required.







# Builders' Guide Info

Please refer to the resources page on our website for the builders guides. Two download links are available,

one for installation of Tray-dec 60/80 and the other for installation of Tray-dec 300.

---

## Concrete Placement

Prior to placing concrete, the trays are to be clean, dry, free of contaminants such as oil or grease and cleared of miscellaneous construction debris. It is also important that the trays are inspected for damage to the zinc coating caused during storage or installation and such damage made good.

Discharge concrete in a controlled manner from no higher than 300mm. Pour the concrete on progressively and evenly without excessive heaping, spreading it at the same time. Compact using a concrete vibrator. Maintain a 1 metre working zone between workers in order to minimise local loading of any one part of individual sheets. Never exceed a construction load of 1.5kPa.

Start the pour sequence over a line of support where the sheet is continuous over that support (i.e. not over a support where the sheet ends or at a butt joint). Place the concrete from the centreline of the support outwards, approximately 1/3 into the span each side of the support. If the sheet ends at the next support line (double span un-propped, single span with 1 prop line, or end span), the remainder of the exposed sheet can then be filled. If the sheets are continuous over the next support (multiple or propped span configuration) then repeat the above (1/3) process before filling the remaining strip of exposed sheet.





# Construction Details

## Shared End Bearing

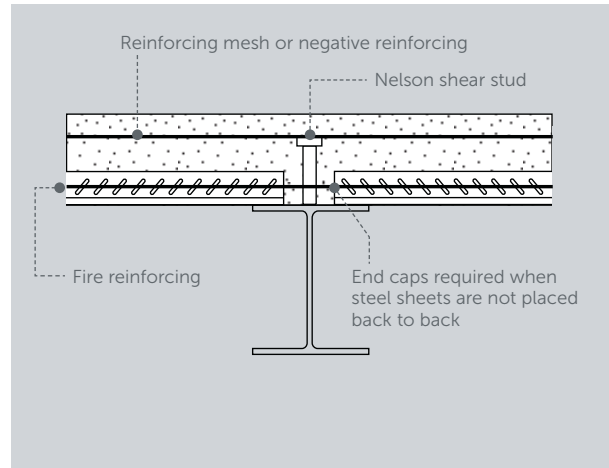
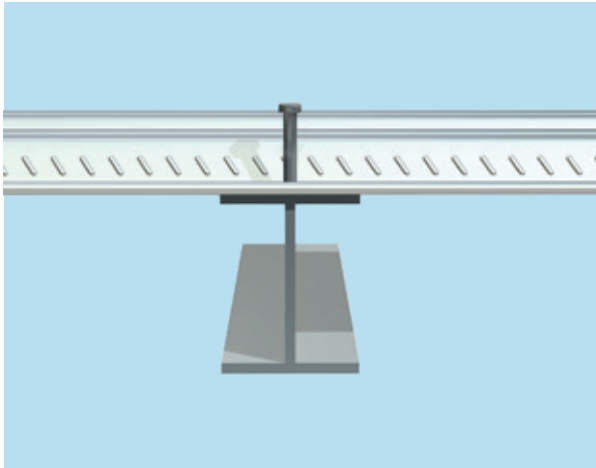

## Flush End Detail

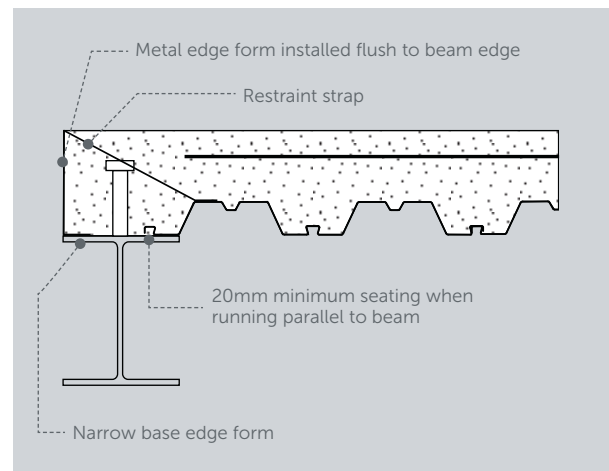
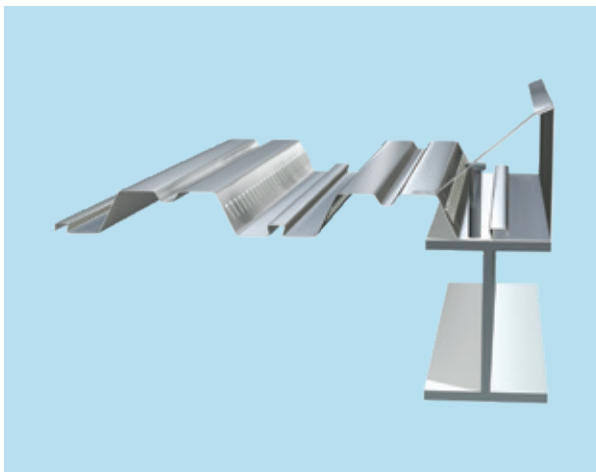

## Edge Cantilever

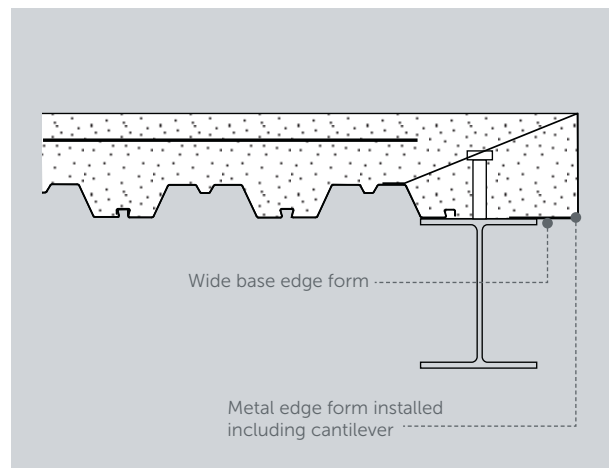
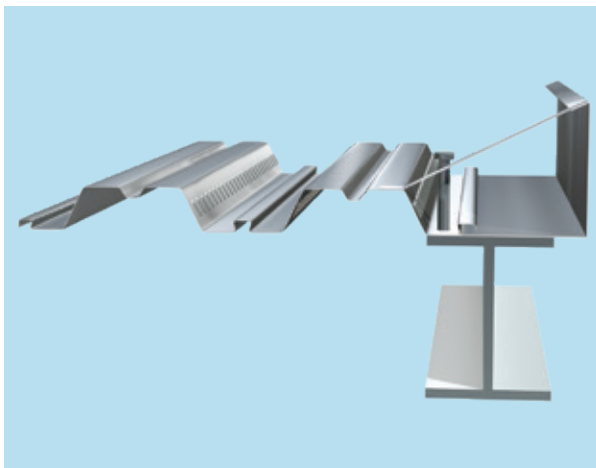





# Construction Details

## Cantilever

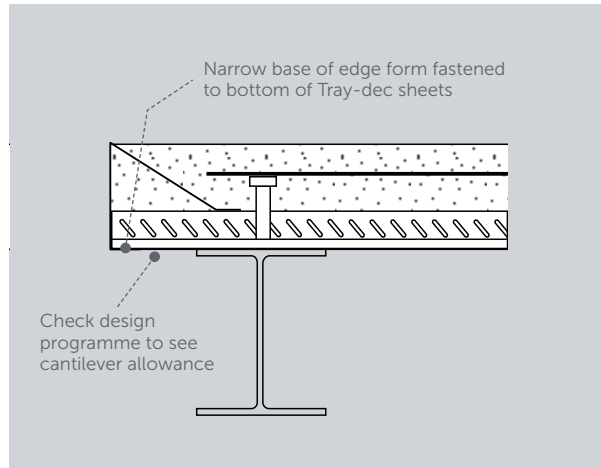
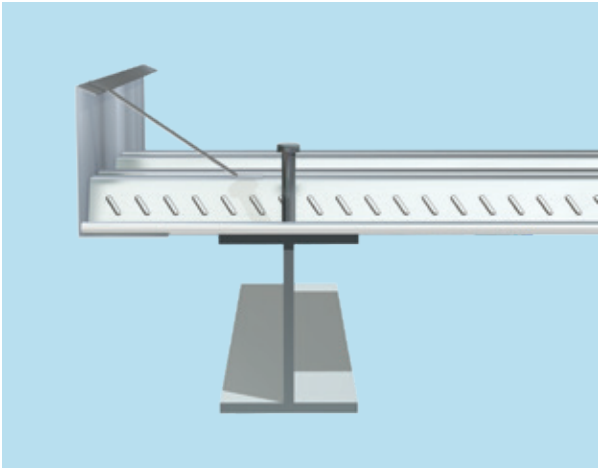

## Side Fixing

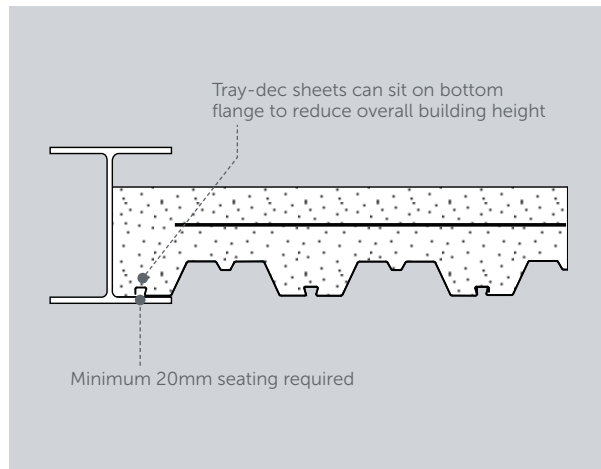
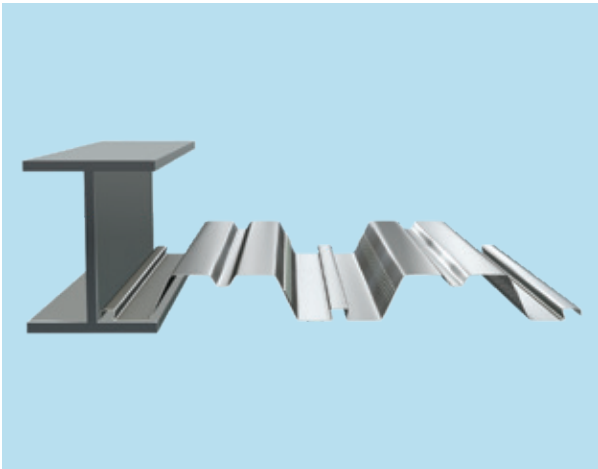

## Steel Angle (inside flange)

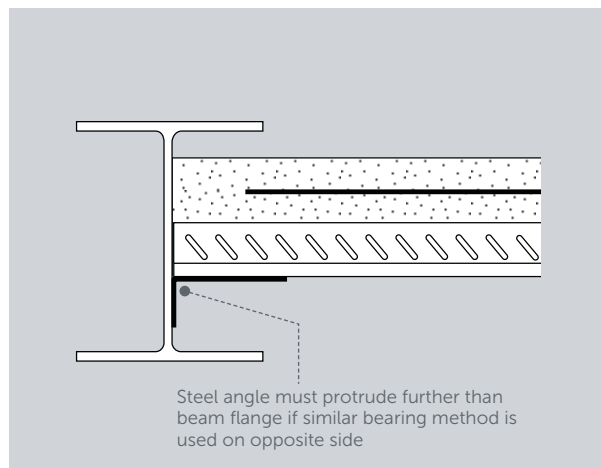
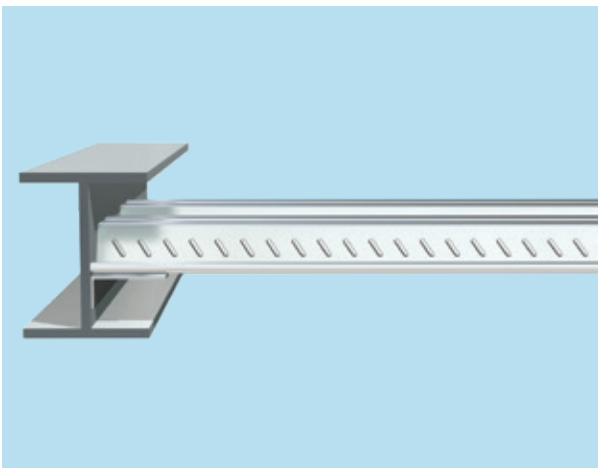



# Construction Details

## Z-Flashing (closure strip)

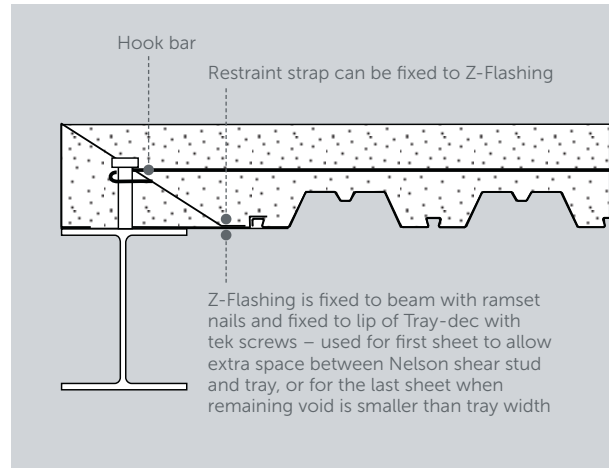
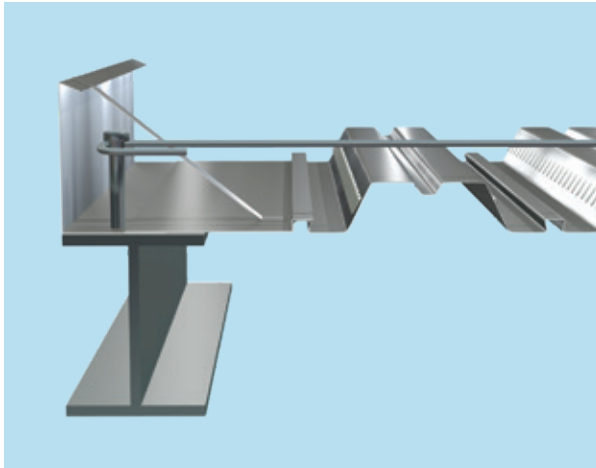

## Block Wall (parallel support)

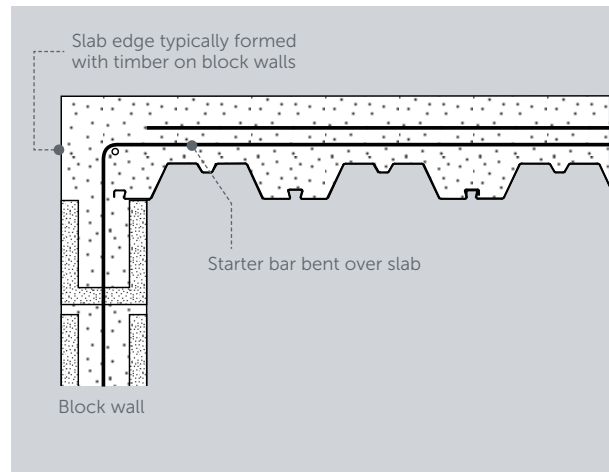
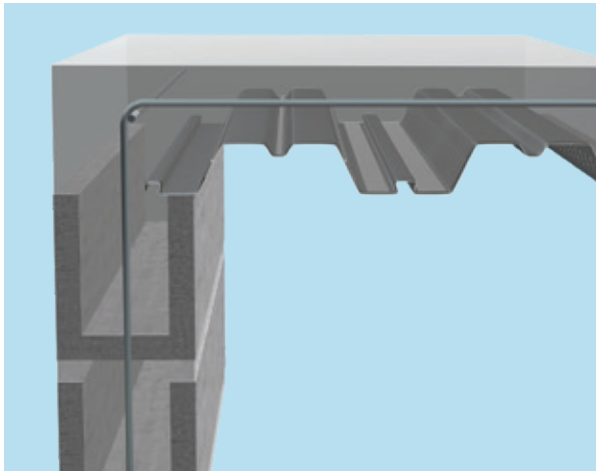

## Block Wall Shared End Bearing

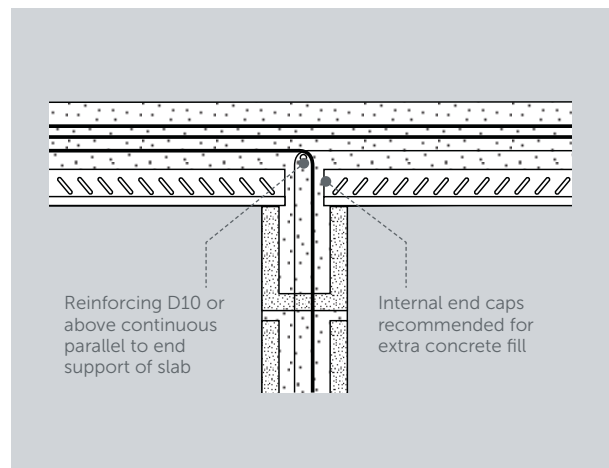
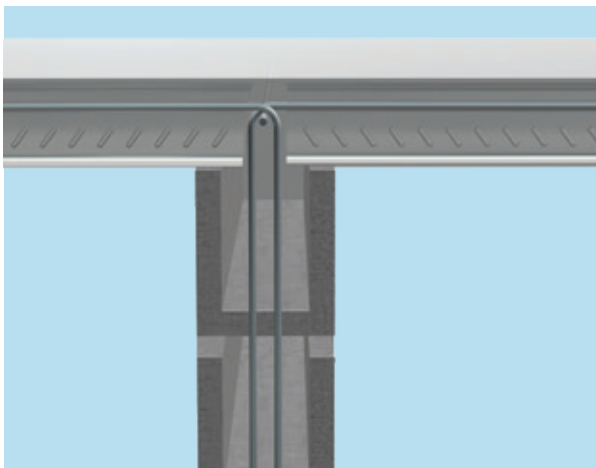





# Construction Details

## **Block Wall (continuous)**

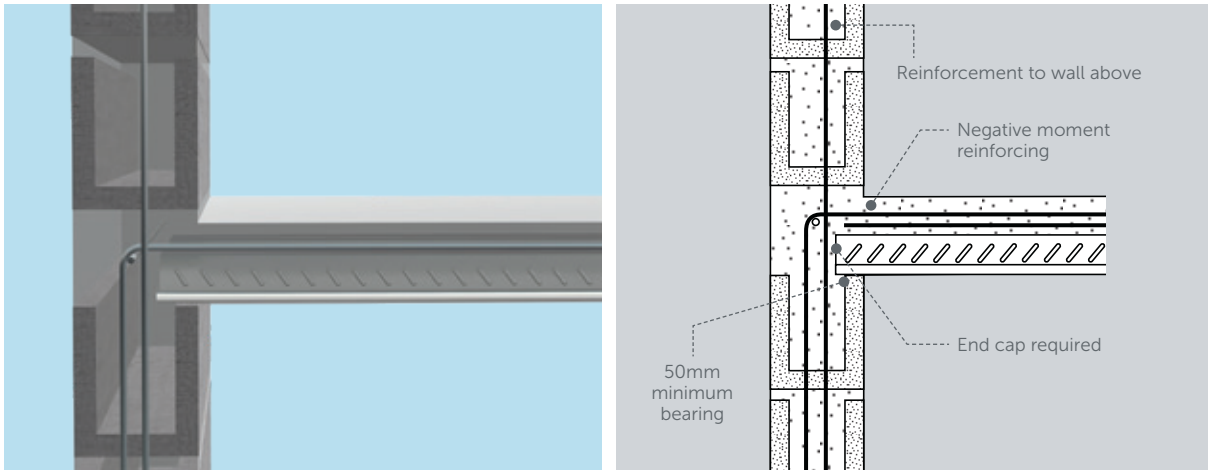

## **Steel Angle (precast)**

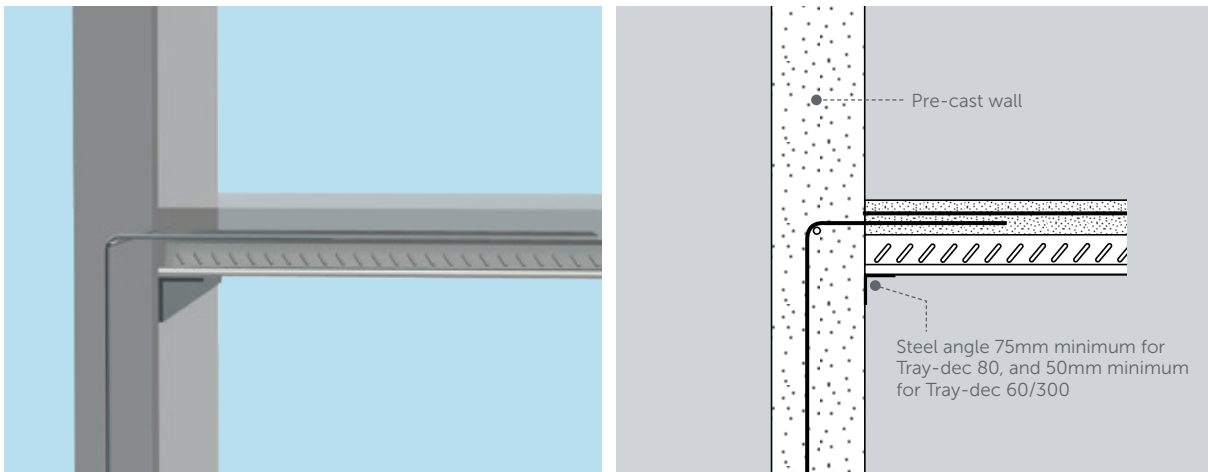

## **Continuous Block Wall (with header block)**

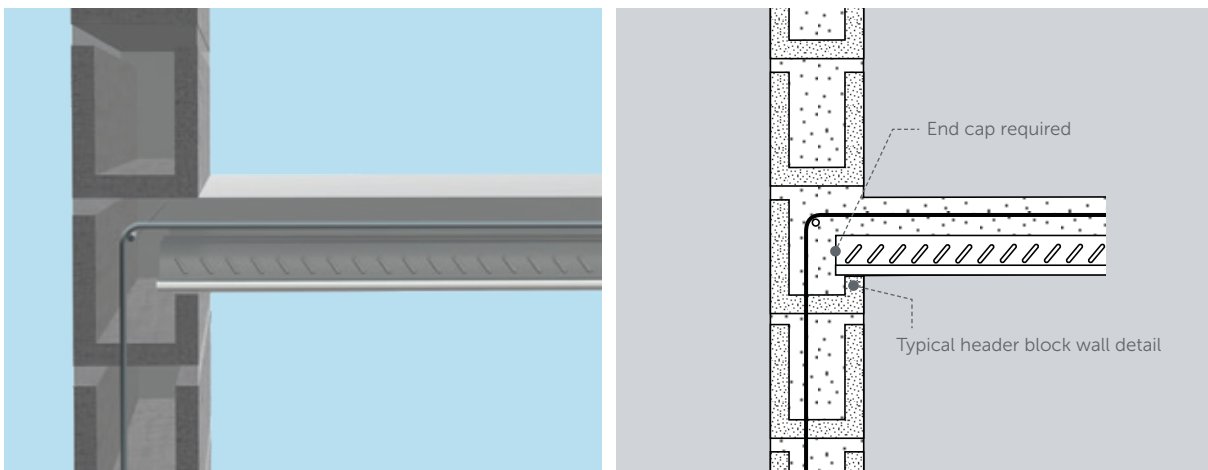



# Acoustics Report

Please refer to the resources page on our website for the most up-to-date acoustics report. This report has been written by Marshall Day Acoustics on the airborne sound insulation performances that are achieved when using the Tray-dec profiles.







# Nelson Shear Stud Properties

## Physical Properties of Shear Connectors

Diameter	A <sub>s</sub> Nominal Area mm <sup>2</sup>	A <sub>s</sub> f <sub>y</sub> Yield Kg (min)	A <sub>s</sub> f <sub>s</sub> Tensile Kg (min)
M13	126.7	4,445	5,334
M16	198.0	6,963	8,355
M19	285.0	10,024	12,029
M22	388.0	13,630	16,356

A<sub>s</sub> Area of stud shank  
 f<sub>s</sub> Ultimate strength (tensile):  
 M13, M16, M19 and M22 420 Mpa min C 0.23 max  
 f<sub>y</sub> Yield strength 345 Mpa min Mn 0.90 max  
 Elongation 20% P 0.04 max  
 Reduction Area 50% min S 0.05 max

Cold Finished low carbon steel

## Nelson Shear Stud Tension Capacity in Concrete

Diameter	Length before weld (1)	Length after weld (2)	Head Diameter	Le (3)	Ultimate tensile strength of anchor (4)	Factored Tension Capacity $\phi V_b$ (kN) (5)								
						Normal Weight Concrete (6)			Standard Light Weight Concrete (7)			All Light Weight Concrete (8)		
						f'c 20.7 MPA	f'c 27.6 MPA	f'c 34.5 MPA	f'c 20.7 MPA	f'c 27.6 MPA	f'c 34.5 MPA	f'c 20.7 MPA	f'c 27.6 MPA	f'c 34.5 MPA
M13	54	50	25	43	42.5	9.0	10.3	11.6	7.6	8.8	9.8	6.7	7.8	8.7
M13	54	50	25	43	42.5	9.0	10.3	11.6	7.6	8.8	9.8	6.7	7.8	8.7
M13	54	50	25	43	42.5	9.0	10.3	11.6	7.6	8.8	9.8	6.7	7.8	8.7
M16	68	63	32	56	66.4	13.2	15.3	17.0	11.2	13.0	14.5	9.9	11.5	12.8
M16	106	100	32	94	66.4	28.9	33.4	37.3	24.6	28.4	31.7	21.7	25.0	28.0
M19	81	75	32	67	95.6	17.4	20.1	22.4	14.8	17.0	19.0	13.1	15.1	16.8
M19	86	80	32	71	95.6	19.3	22.2	24.9	16.4	18.9	21.1	14.5	16.7	18.6
M19	98	92	32	84	95.6	24.6	28.5	31.8	21.0	24.2	27.0	18.5	21.3	23.8
M19	106	100	32	92	95.6	28.2	32.5	36.4	24.0	27.7	30.9	21.1	24.4	27.3
M19	111	105	32	97	95.6	30.4	35.1	39.2	25.8	29.8	33.4	22.8	26.3	29.4
M19	132	125	32	118	95.6	40.6	46.9	52.5	34.5	39.9	44.6	30.5	35.2	39.3
M19	157	150	32	143	95.6	54.5	63.0	70.4	46.3	53.5	59.8	40.9	47.2	52.8
M19	183	175	32	168	95.6	69.7	80.5	90.0	59.2	68.4	76.5	52.3	60.3	67.4
M19	208	200	32	194	95.6	86.0	95.6	95.6	73.1	84.4	94.4	64.5	74.5	83.3
M22	106	100	35	92	130.1	28.2	32.5	36.4	24.0	27.7	30.9	21.1	24.4	27.3
M22	183	175	35	168	130.1	69.7	80.5	90.0	59.2	68.4	76.5	52.3	60.3	67.4
M22	208	200	35	194	130.1	86.0	99.3	111.0	73.1	84.4	94.4	64.5	74.5	83.3

### NOTES:

- (1.) Stock anchor size.
- (2.) A.W. = Length overall after welding.
- (3.) Le = Length of embedment under head of anchor. Ignores thickness of an embedment plate which will increase Le.
- (4.)  $\phi N_s = 0.75 A_s f_s$

- (5.)  $\phi N_b = 0.70 \lambda x 24 \sqrt{f'c} L e \exp 1.5$ , where  $\phi N_b > \phi N_s$ ,  $\phi N_s$  governs as  $\phi N_n$ . Assumes no supplemental reinforcement. Pullout and side-face blowout strengths not considered.
- (6.) NWT = normal- weight concrete ( $\lambda = 1.0$ ).
- (7.) SLWT = sand lightweight concrete ( $\lambda = 0.85$ ).
- (8.) ALWT = All lightweight concrete ( $\lambda = 0.75$ ).



# Nelson Shear Stud Properties

## Nelson Shear Stud Shear Capacity in Concrete

Diameter	Length before weld (1)	Length after weld (2)	H/Ds (no. of diameters)	Factored Steel Shear Strength (kN) (3)	Factored Shear Breakout Capacity $\phi V_b$ (kN) (4)(5)								
					Normal Weight Concrete (6)			Standard Light Weight Concrete (7)			All Light Weight Concrete (8)		
					f'c 20.7 MPA	f'c 27.6 MPA	f'c 34.5 MPA	f'c 20.7 MPA	f'c 27.6 MPA	f'c 34.5 MPA	f'c 20.7 MPA	f'c 27.6 MPA	f'c 34.5 MPA
M13	54	50	3.4	36.9	15.8	18.2	20.4	13.4	15.5	17.3	11.9	13.7	15.3
M13	105	100	7.4	36.9	18.5	21.3	23.8	15.7	18.1	20.2	13.9	16.0	17.9
M13	156	150	11.4	36.9	20.2	23.3	26.0	17.1	19.8	22.1	15.1	17.4	19.5
M16	68	63	3.5	57.5	17.8	20.6	23.0	15.1	17.4	19.5	13.3	15.4	17.2
M16	106	100	5.9	57.5	19.8	22.8	25.5	16.8	19.4	21.7	14.8	17.1	19.1
M19	81	75	3.5	82.9	19.5	22.5	25.2	16.6	19.1	21.4	14.6	16.9	18.9
M19	86	80	3.8	82.9	19.8	22.8	25.5	16.8	19.4	21.7	14.8	17.1	19.1
M19	98	92	4.4	82.9	20.4	23.6	26.4	17.4	20.0	22.4	15.3	17.7	19.8
M19	106	100	4.8	82.9	20.8	24.0	26.8	17.7	20.4	22.8	15.6	18.0	20.1
M19	111	105	5.1	82.9	21.0	24.2	27.1	17.8	20.6	23.0	15.8	18.2	20.3
M19	132	125	6.2	82.9	21.8	25.2	28.2	18.6	21.4	23.9	16.4	18.9	21.1
M19	157	150	7.5	82.9	22.7	26.2	29.3	19.3	22.3	24.9	17.0	19.7	22.0
M19	183	175	8.8	82.9	23.4	27.1	30.3	19.9	23.0	25.8	17.6	20.3	22.7
M19	208	200	10.2	82.9	24.1	27.8	31.1	20.5	23.7	26.5	18.1	20.9	23.4
M22	106	100	4.1	112.8	21.8	25.1	28.1	18.5	21.4	23.9	16.3	18.9	21.1
M22	183	175	6.4	112.8	22.5	26.0	29.1	19.1	22.1	24.7	16.9	19.5	21.8
M22	208	200	7.0	112.8	22.5	26.0	29.1	19.1	22.1	24.7	16.9	19.5	21.8

### NOTES:

(1.) Stock anchor size.

(2.) A.W. = Length overall after welding.

(3.)  $L_e$  = Length of embedment under head of anchor. Ignores thickness of an embedment plate which will increase  $L_e$ .

(4.)  $\phi N_s = 0.75A_s f_s$

(5.)  $\phi N_b = 0.70 \lambda \lambda \lambda 24 \sqrt{f'c} L_e \exp 1.5$ , where  $\phi N_b > \phi N_s$ ,  $\phi N_s$  governs as  $\phi N_n$ . Assumes no supplemental reinforcement. Pullout and side-face blowout strengths not considered.

(6.) NWT = normal- weight concrete ( $\lambda = 1.0$ ).

(7.) SLWT = sand lightweight concrete ( $\lambda = 0.85$ ).

(8.) ALWT = All lightweight concrete ( $\lambda = 0.75$ ).